



**POLSKI KOMITET
NORMALIZACYJNY**

P O L S K A N O R M A

ICS 25.160.40

PN-EN ISO 11666

Wprowadza

EN ISO 11666:2018, IDT

ISO 11666:2018, IDT

Zastępuje

PN-EN ISO 11666:2011

Badania nieniszczące spoin

Badania ultradźwiękowe

Poziomy akceptacji

Norma Europejska EN ISO 11666:2018 *Non-destructive testing of welds – Ultrasonic testing – Acceptance levels (ISO 11666:2018)* ma status Polskiej Normy

© Copyright by PKN, Warszawa 2018

nr ref. PN-EN ISO 11666:2018-04

Wszelkie prawa autorskie zastrzeżone. Żadna część niniejszej publikacji nie może być zwielokrotniana jakkolwiek techniką bez pisemnej zgody Prezesa Polskiego Komitetu Normalizacyjnego

ISBN 978-83-275-9388-7

PN-EN ISO 11666:2018-04

Przedmowa krajowa

Niniejsza norma została zatwierdzona przez Prezesa PKN dnia 13 kwietnia 2018 r.

Komitetem krajowym odpowiedzialnym za normę jest KT nr 165 ds. Spawania i Procesów pokrewnych.

Istnieje możliwość przetłumaczenia normy na język polski na wniosek zainteresowanych środowisk. Decyzję podejmuje właściwy Komitet Techniczny.

Niniejsza norma zastępuje PN-EN ISO 11666:2011.

Odpowiedniki krajowe norm i innych dokumentów powołanych w niniejszej normie można znaleźć w katalogu Polskich Norm. Oryginały norm i innych dokumentów powołanych są dostępne w PKN.

W sprawach merytorycznych dotyczących treści normy można zwracać się do właściwego Komitetu Technicznego lub właściwej Rady Sektorowej PKN, kontakt: www.pkn.pl

Nota uznaniowa

Norma Europejska EN ISO 11666:2018 została uznana przez PKN za Polską Normę PN-EN ISO 11666:2018-04.

EUROPEAN STANDARD

EN ISO 11666

NORME EUROPÉENNE

EUROPÄISCHE NORM

February 2018

ICS 25.160.40

Supersedes EN ISO 11666:2010

English Version

Non-destructive testing of welds - Ultrasonic testing - Acceptance levels (ISO 11666:2018)

Essais non destructifs des assemblages soudés -
Contrôle par ultrasons - Niveaux d'acceptation (ISO
11666:2018)

Zerstörungsfreie Prüfung von Schweißverbindungen -
Ultraschallprüfung - Zulässigkeitsgrenzen (ISO
11666:2018)

This European Standard was approved by CEN on 21 January 2018.

CEN members are bound to comply with the CEN/CENELEC Internal Regulations which stipulate the conditions for giving this European Standard the status of a national standard without any alteration. Up-to-date lists and bibliographical references concerning such national standards may be obtained on application to the CEN-CENELEC Management Centre or to any CEN member.

This European Standard exists in three official versions (English, French, German). A version in any other language made by translation under the responsibility of a CEN member into its own language and notified to the CEN-CENELEC Management Centre has the same status as the official versions.

CEN members are the national standards bodies of Austria, Belgium, Bulgaria, Croatia, Cyprus, Czech Republic, Denmark, Estonia, Finland, Former Yugoslav Republic of Macedonia, France, Germany, Greece, Hungary, Iceland, Ireland, Italy, Latvia, Lithuania, Luxembourg, Malta, Netherlands, Norway, Poland, Portugal, Romania, Serbia, Slovakia, Slovenia, Spain, Sweden, Switzerland, Turkey and United Kingdom.



EUROPEAN COMMITTEE FOR STANDARDIZATION
COMITÉ EUROPÉEN DE NORMALISATION
EUROPÄISCHES KOMITEE FÜR NORMUNG

CEN-CENELEC Management Centre: Rue de la Science 23, B-1040 Brussels

EN ISO 11666:2018 (E)

Contents	Page
European foreword.....	3

European foreword

This document (EN ISO 11666:2018) has been prepared by Technical Committee ISO/TC 44 "Welding and allied processes" in collaboration with Technical Committee CEN/TC 121 "Welding and allied processes", the secretariat of which is held by DIN.

This European Standard shall be given the status of a national standard, either by publication of an identical text or by endorsement, at the latest by August 2018, and conflicting national standards shall be withdrawn at the latest by August 2018.

Attention is drawn to the possibility that some of the elements of this document may be the subject of patent rights. CEN shall not be held responsible for identifying any or all such patent rights.

This document supersedes EN ISO 11666:2010.

According to the CEN-CENELEC Internal Regulations, the national standards organizations of the following countries are bound to implement this European Standard: Austria, Belgium, Bulgaria, Croatia, Cyprus, Czech Republic, Denmark, Estonia, Finland, Former Yugoslav Republic of Macedonia, France, Germany, Greece, Hungary, Iceland, Ireland, Italy, Latvia, Lithuania, Luxembourg, Malta, Netherlands, Norway, Poland, Portugal, Romania, Serbia, Slovakia, Slovenia, Spain, Sweden, Switzerland, Turkey and the United Kingdom.

Endorsement notice

The text of ISO 11666:2018 has been approved by CEN as EN ISO 11666:2018 without any modification.

INTERNATIONAL
STANDARD

ISO
11666

Second edition
2018-01

**Non-destructive testing of welds —
Ultrasonic testing — Acceptance levels**

*Essais non destructifs des assemblages soudés — Contrôle par
ultrasons — Niveaux d'acceptation*



Reference number
ISO 11666:2018(E)

© ISO 2018

ISO 11666:2018(E)



COPYRIGHT PROTECTED DOCUMENT

© ISO 2018

All rights reserved. Unless otherwise specified, or required in the context of its implementation, no part of this publication may be reproduced or utilized otherwise in any form or by any means, electronic or mechanical, including photocopying, or posting on the internet or an intranet, without prior written permission. Permission can be requested from either ISO at the address below or ISO's member body in the country of the requester.

ISO copyright office
CP 401 • Ch. de Blandonnet 8
CH-1214 Vernier, Geneva, Switzerland
Tel. +41 22 749 01 11
Fax +41 22 749 09 47
copyright@iso.org
www.iso.org

Published in Switzerland

Contents

	Page
Foreword	iv
1 Scope	1
2 Normative references	1
3 Terms and definitions	1
4 Determination of discontinuity length	2
5 Sensitivity setting and levels	2
6 Acceptance levels	2
6.1 General	2
6.2 Indications from longitudinal discontinuities	3
6.3 Indications from transverse discontinuities	3
6.4 Grouping of discontinuities	3
6.5 Length of acceptable discontinuities	4
Annex A (normative) Levels	6
Annex B (normative) Fixed-amplitude level technique	17

ISO 11666:2018(E)

Foreword

ISO (the International Organization for Standardization) is a worldwide federation of national standards bodies (ISO member bodies). The work of preparing International Standards is normally carried out through ISO technical committees. Each member body interested in a subject for which a technical committee has been established has the right to be represented on that committee. International organizations, governmental and non-governmental, in liaison with ISO, also take part in the work. ISO collaborates closely with the International Electrotechnical Commission (IEC) on all matters of electrotechnical standardization.

The procedures used to develop this document and those intended for its further maintenance are described in the ISO/IEC Directives, Part 1. In particular the different approval criteria needed for the different types of ISO documents should be noted. This document was drafted in accordance with the editorial rules of the ISO/IEC Directives, Part 2 (see www.iso.org/directives).

Attention is drawn to the possibility that some of the elements of this document may be the subject of patent rights. ISO shall not be held responsible for identifying any or all such patent rights. Details of any patent rights identified during the development of the document will be in the Introduction and/or on the ISO list of patent declarations received (see www.iso.org/patents).

Any trade name used in this document is information given for the convenience of users and does not constitute an endorsement.

For an explanation on the voluntary nature of standards, the meaning of ISO specific terms and expressions related to conformity assessment, as well as information about ISO's adherence to the World Trade Organization (WTO) principles in the Technical Barriers to Trade (TBT) see the following URL: www.iso.org/iso/foreword.html.

This document was prepared by Technical Committee ISO/TC 44, *Welding and allied processes*, Subcommittee SC 5, *Testing and inspection of welds*.

This second edition cancels and replaces the first edition (ISO 11666:2010), which has been technically revised.

The main changes compared to the previous edition are as follows:

- this document has been editorially revised;
- the normative reference to ISO 5817 has been dated;
- [Clause 5](#) and [6.5](#) have been described in more detail.

Requests for official interpretations of any aspect of this document should be directed to the Secretariat of ISO/TC 44/SC 5 via your national standards body. A complete listing of these bodies can be found at www.iso.org.

Non-destructive testing of welds — Ultrasonic testing — Acceptance levels

1 Scope

This document specifies two ultrasonic acceptance levels known as acceptance level 2 (AL 2) and acceptance level 3 (AL 3) for full penetration welded joints in ferritic steels, which correspond to ISO 5817:2014, quality levels B and C. An acceptance level corresponding to ISO 5817:2014, quality level D is not included in this document, as ultrasonic testing is generally not requested for this weld quality.

These acceptance levels are applicable to testing carried out in accordance with ISO 17640.

This document applies to the testing of full penetration ferritic steel welds, with thicknesses from 8 mm to 100 mm. It can also be used for other types of welds, materials and thicknesses, provided the tests have been performed with necessary consideration of the geometry and acoustic properties of the component, and an adequate sensitivity can be employed to enable the acceptance levels of this document to be applied. The nominal frequency of probes used in this document is between 2 MHz and 5 MHz, unless attenuation or requirements for higher resolution call for other frequencies. It is important to consider the use of these acceptance levels in conjunction with frequencies outside this range carefully.

2 Normative references

The following documents are referred to in the text in such a way that some or all of their content constitutes requirements of this document. For dated references, only the edition cited applies. For undated references, the latest edition of the referenced document (including any amendments) applies.

ISO 5577, *Non-destructive testing — Ultrasonic testing — Vocabulary*

ISO 5817:2014, *Welding — Fusion-welded joints in steel, nickel, titanium and their alloys (beam welding excluded) — Quality levels for imperfections*

ISO 17635, *Non-destructive testing of welds — General rules for metallic materials*

ISO 17640, *Non-destructive testing of welds — Ultrasonic testing — Techniques, testing levels, and assessment*

ISO 23279, *Non-destructive testing of welds — Ultrasonic testing — Characterization of discontinuities in welds*

3 Terms and definitions

For the purposes of this document, the terms and definitions given in ISO 5577 apply.

ISO and IEC maintain terminological databases for use in standardization at the following addresses:

- ISO Online browsing platform: available at <https://www.iso.org/obp>
- IEC Electropedia: available at <http://www.electropedia.org/>

ISO 11666:2018(E)

4 Determination of discontinuity length

The length of a discontinuity shall be determined by measuring the distance along the length over which the echo amplitude is above the evaluation level, using the fixed-amplitude level technique specified in [Annex B](#).

5 Sensitivity setting and levels

The sensitivity setting shall be performed by one of the following techniques. For sensitivity setting and the subsequent testing, the same technique shall be used.

- a) Technique 1: based on 3 mm diameter side-drilled holes.
- b) Technique 2: based on distance-gain-size (DGS) curves for flat-bottomed holes (disk-shaped reflectors).
- c) Technique 3: using a distance-amplitude-corrected (DAC) curve of a rectangular notch of 1 mm depth and 1 mm width.
- d) Technique 4: using the tandem technique with reference to a 6 mm diameter flat-bottomed hole (disk-shaped reflector).

Four levels as defined in ISO 17640 are to be used:

- a) reference level;
- b) acceptance levels (for two quality levels);
- c) recording levels (recording levels are 4 dB below the corresponding acceptance levels);
- d) evaluation level.

All levels are linked to the reference reflectors specified in [Table A.1](#).

The sensitivity setting techniques and corresponding levels shall be in accordance with [Annex A](#).

6 Acceptance levels

6.1 General

The relationship between acceptance levels, testing levels and quality levels is given in ISO 17635. See also [Table 1](#).

Table 1 — Ultrasonic pulse-echo technique (UT)

Quality level in accordance with ISO 5817:2014	Testing level in accordance with ISO 17640 ^a	Acceptance level in accordance with this document
B	At least B	2
C	At least A	3
D	At least A	3 ^b
^a When characterization of discontinuities is required, ISO 23279 shall be applied. ^b UT is not recommended but may be defined in a specification (with the same requirements as quality level C).		

The acceptance levels in this document are valid for all testing levels and for all techniques as defined in ISO 17640, including tests with straight-beam probes.

If characterization has been specified in accordance with ISO 23279, planar discontinuities are not acceptable and for non-planar discontinuities, the acceptance levels in this document apply.

If characterization has not been specified, the acceptance levels in this document apply to all discontinuities.

6.2 Indications from longitudinal discontinuities

[Table A.1](#) gives information on the techniques used for evaluation of discontinuities according to ISO 17640 and the related evaluation and acceptance levels. [Table A.2](#) specifies the reference levels for acceptance levels 2 and 3 for technique 2 using angle-beam scanning with transverse waves. [Table A.3](#) specifies the reference levels for acceptance levels 2 and 3 for technique 2 using straight-beam scanning with longitudinal waves.

For techniques 1 (side-drilled holes) and 3 (rectangular notch), see [Figures A.1](#) to [A.4](#).

For techniques 2 [flat-bottomed holes (disk-shaped reflectors)] and 4 (tandem technique), see [Figures A.5](#) to [A.10](#).

Any discontinuities providing an amplitude below the acceptance level but with a length (above evaluation level) exceeding t , for the thickness range of $8 \text{ mm} \leq t < 15 \text{ mm}$, or $t/2$ or 20 mm, whichever is larger, for all other thickness ranges, shall be subject to further testing. This requires the use of additional beam angle(s), and, if specified, the tandem technique.

The final evaluation shall be based on the maximum echo amplitude and length measured.

6.3 Indications from transverse discontinuities

When detection of transverse discontinuities is specified, the acceptance levels stated in [6.2](#) apply.

6.4 Grouping of discontinuities

Grouping of discontinuities is based on the length and the separation of individually acceptable discontinuities providing amplitudes above the recording level. The length of a group shall not be used for further grouping.

For evaluation, a group of discontinuities shall be considered as a single one if:

- a) the distance, d_x , between two discontinuities is less than twice the length of the longer discontinuity (see [Figure 1](#));
- b) the distance, d_y , between two discontinuities is less than half of the thickness but not more than 10 mm; and
- c) the distance, d_z , between two discontinuities is less than half of the thickness but not more than 10 mm.

The combined length of the group of two discontinuities is $l_{12} = l_1 + l_2 + d_x$ (see [Figure 2](#)).

The combined length, l_{12} , and the larger maximum amplitude of the two discontinuities shall then be assessed against the applicable acceptance levels given in [Table A.1](#).

ISO 11666:2018(E)

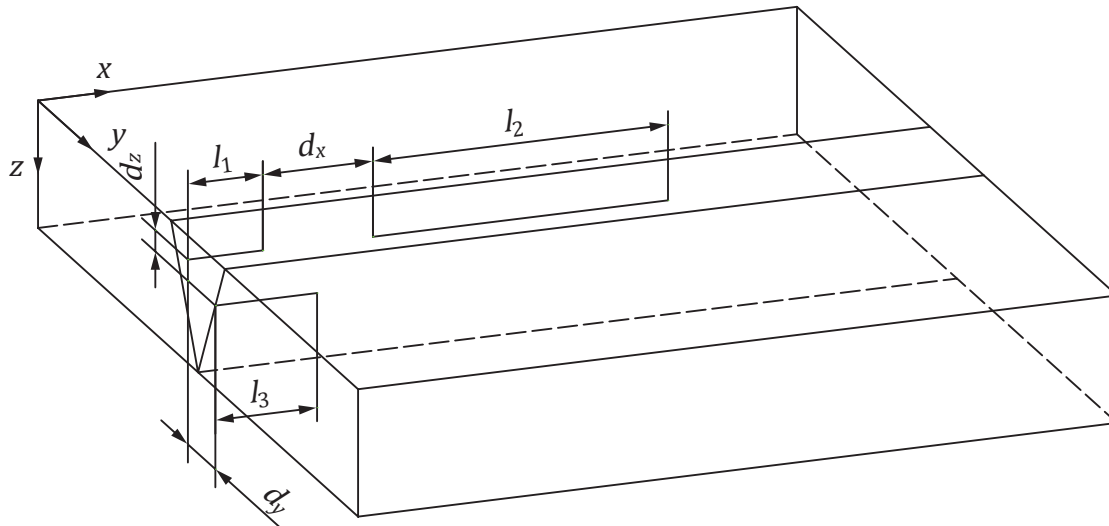
**Key**

d_x, d_y, d_z distances in the x -, y -, and z -direction, respectively

l_n individual discontinuities, where $n = 1, \dots, 3$

Figure 1 — Geometric configuration for grouped discontinuities

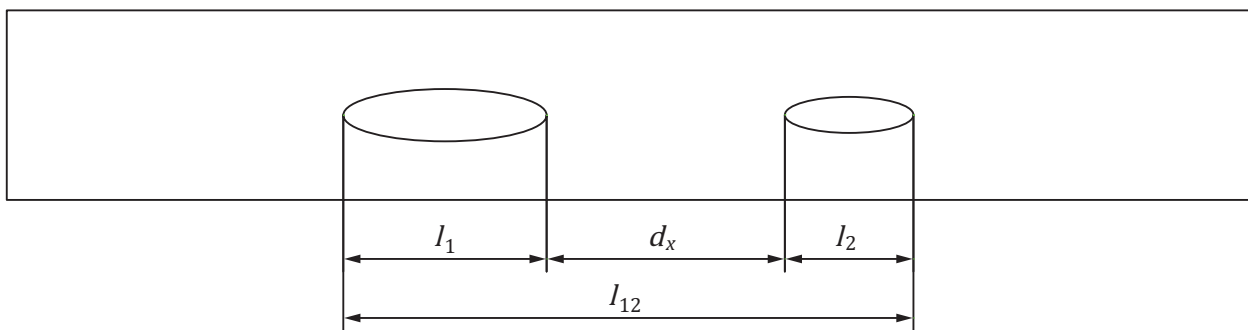
**Key**

d_x distance in the x -direction

l_1, l_2 individual discontinuities

l_{12} combined length

Figure 2 — Length of a group of discontinuities

6.5 Length of acceptable discontinuities

The length of a single acceptable discontinuity above recording level shall be evaluated according to the criteria in this subclause.

The cumulative length of all individually acceptable discontinuities above recording level is given as the sum of lengths of both single discontinuities and linearly aligned discontinuities of combined length within a given section of weld length (see [Figure 3](#)).

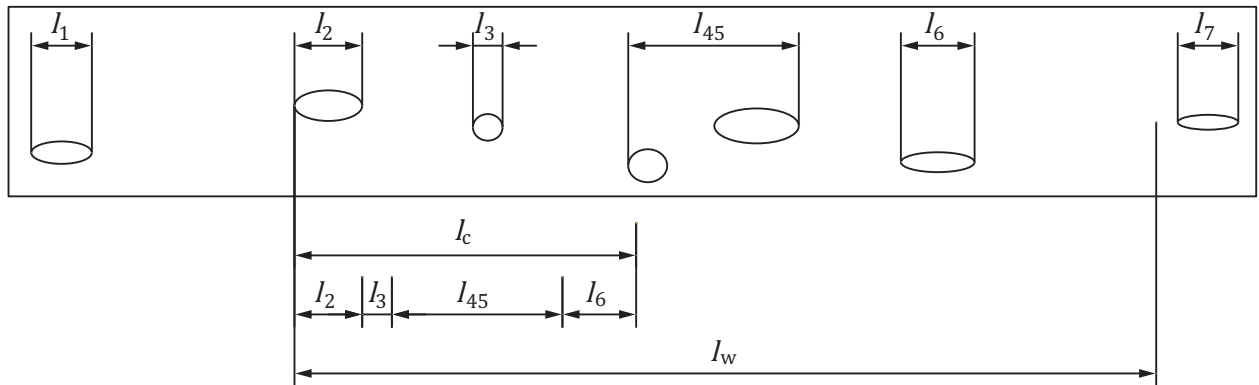
**Key**

l_c cumulative length

$$l_c = l_2 + l_3 + l_{45} + l_6$$

l_w section of weld length ($6 \times$ thickness t)

l_n individual discontinuities, where $n = 1, \dots, 7$

Figure 3 — Cumulative length of discontinuities

For any section of weld length, $l_w = 6t$, the maximum cumulative length, l_c , of all individually acceptable discontinuities above the recording level shall not exceed 20 % of l_w for acceptance level 2, or 30 % of l_w for acceptance level 3.

Annex A (normative)

Levels

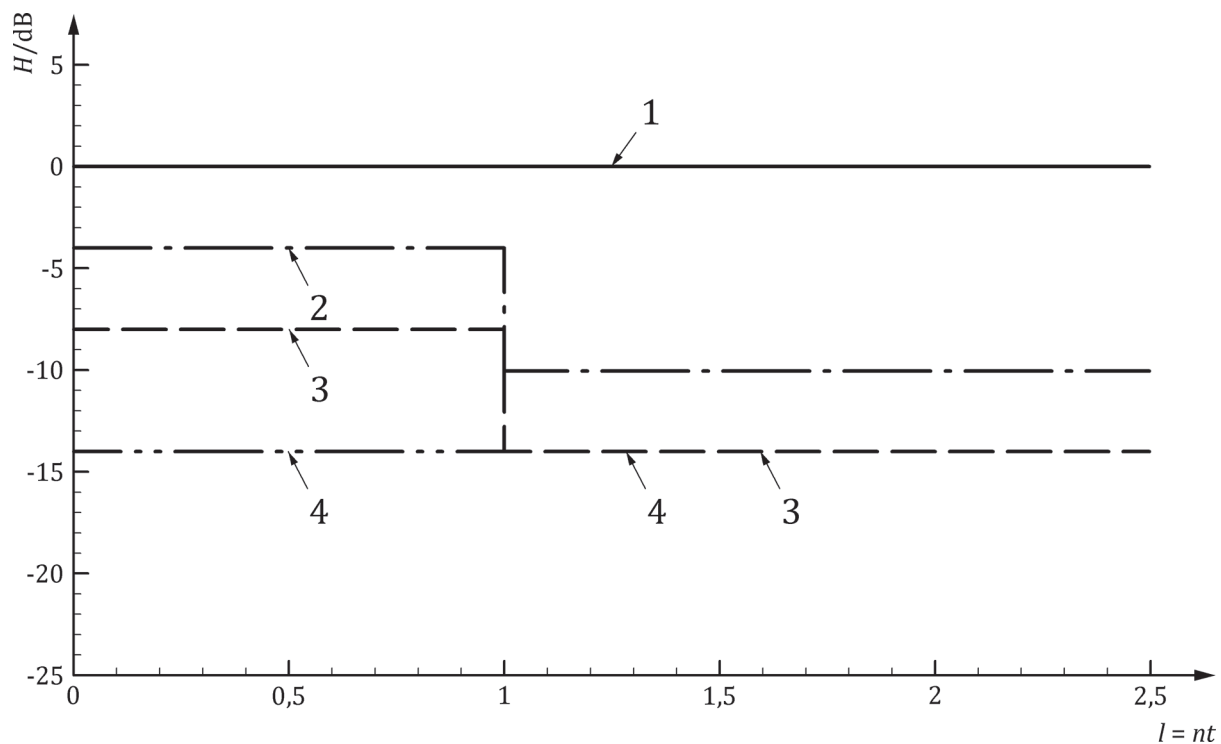

Key

- 1 reference level
- 2 acceptance level 2
- 3 recording level
- 4 evaluation level
- H amplitude
- l length of discontinuities
- n multiplier of t
- t thickness

Figure A.1 — Levels for techniques 1 and 3 for thicknesses 8 mm to 15 mm — Acceptance level 2

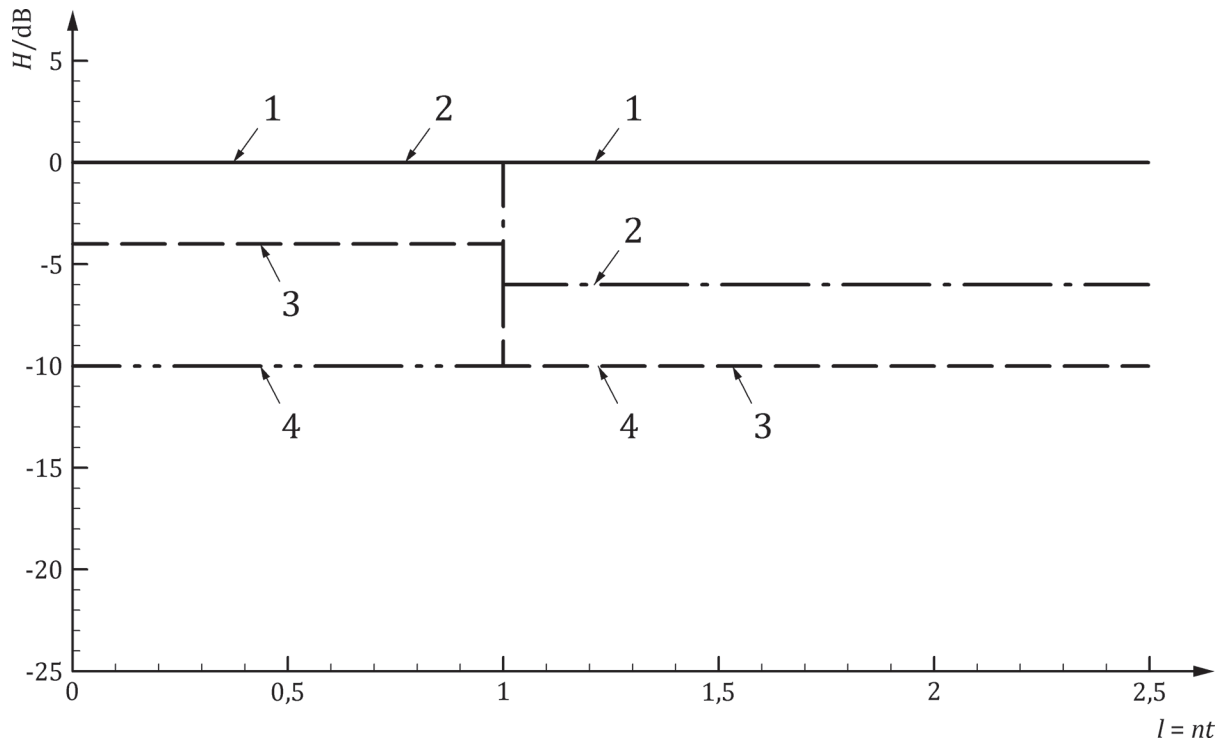
**Key**

- 1 reference level
- 2 acceptance level 3
- 3 recording level
- 4 evaluation level
- H amplitude
- l length of discontinuities
- n multiplier of t
- t thickness

Figure A.2 — Levels for techniques 1 and 3 for thicknesses 8 mm to 15 mm — Acceptance level 3

ISO 11666:2018(E)

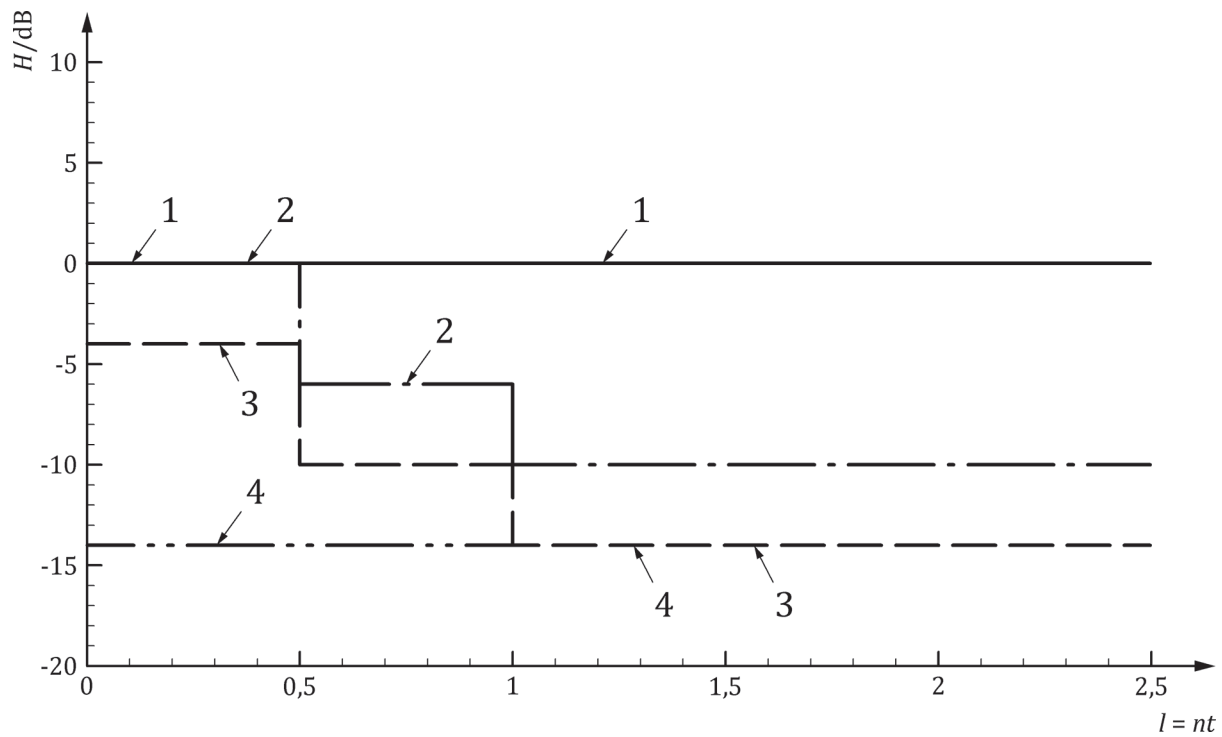
**Key**

- 1 reference level
- 2 acceptance level 2
- 3 recording level
- 4 evaluation level
- H amplitude
- l length of discontinuities
- n multiplier of t
- t thickness

Figure A.3 — Levels for technique 1 for thicknesses 15 mm to 100 mm — Acceptance level 2

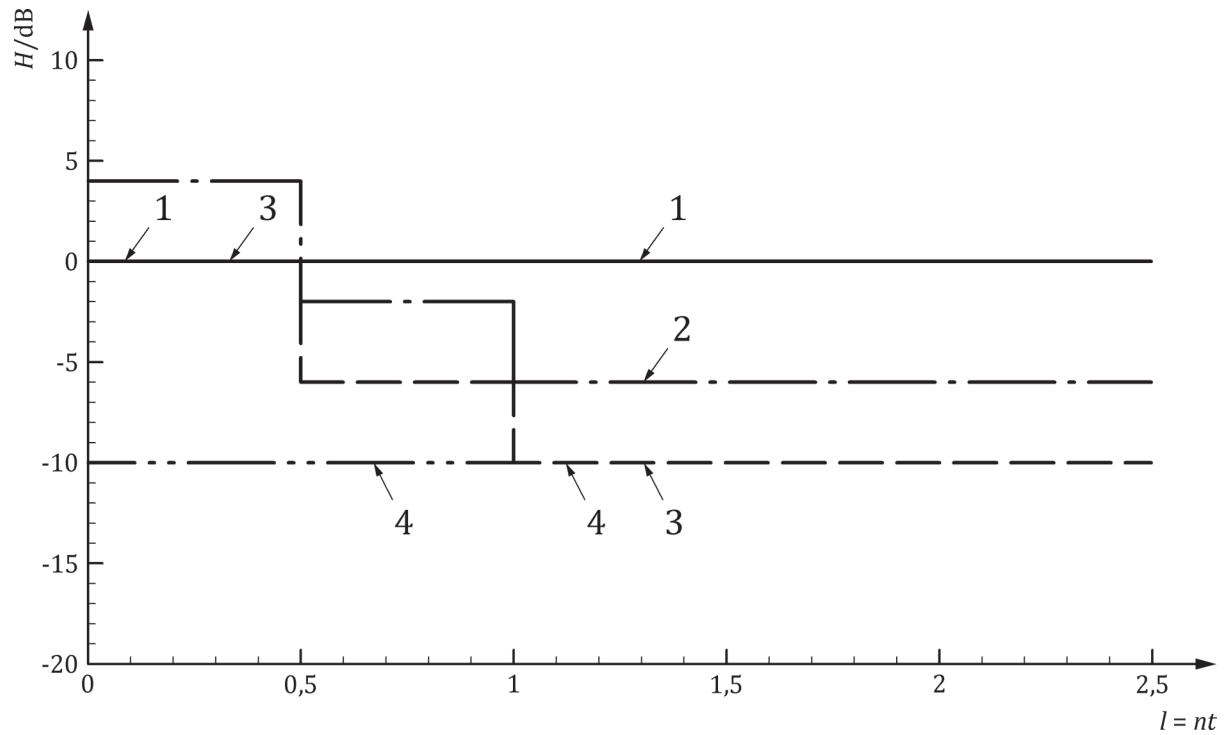
**Key**

- 1 reference level
- 2 acceptance level 3
- 3 recording level
- 4 evaluation level
- H amplitude
- l length of discontinuities
- n multiplier of t
- t thickness

Figure A.4 — Levels for technique 1 for thicknesses 15 mm to 100 mm — Acceptance level 3

ISO 11666:2018(E)

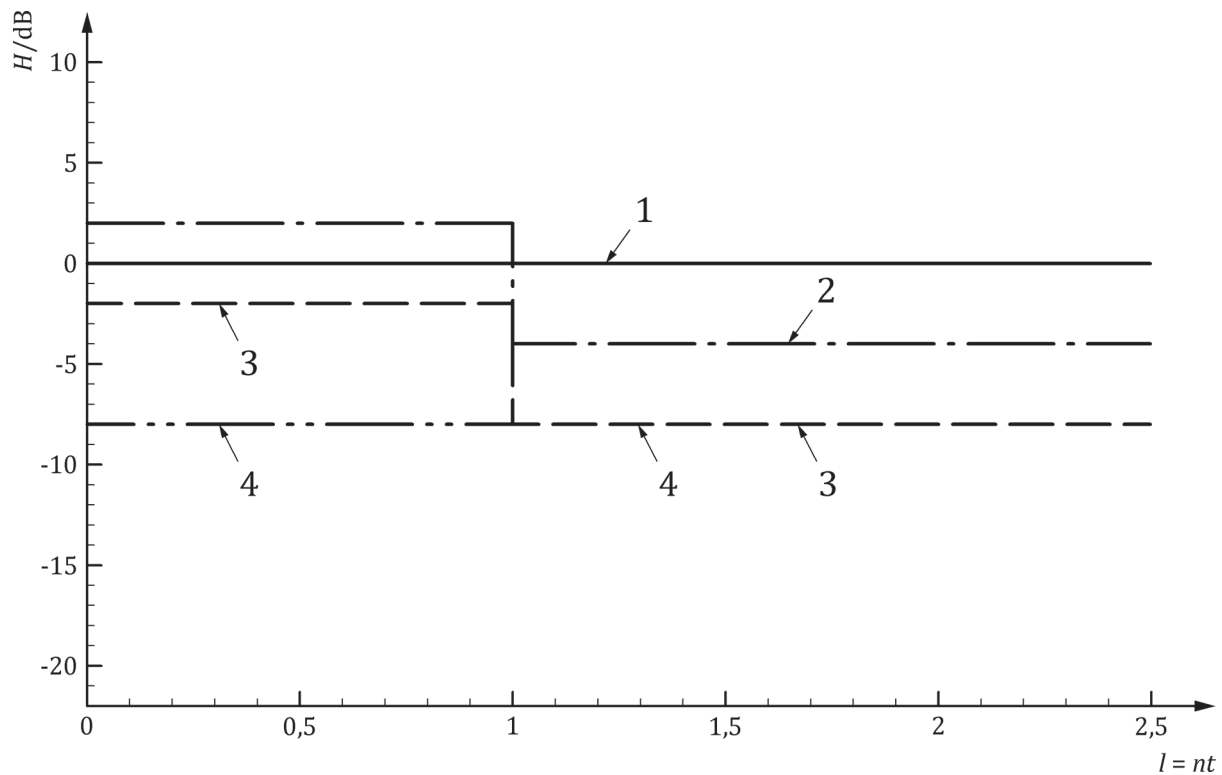
**Key**

- 1 reference level
- 2 acceptance level 2
- 3 recording level
- 4 evaluation level
- H amplitude
- l length of discontinuities
- n multiplier of t
- t thickness

Figure A.5 — Levels for technique 2 for thicknesses 8 mm to 15 mm — Acceptance level 2

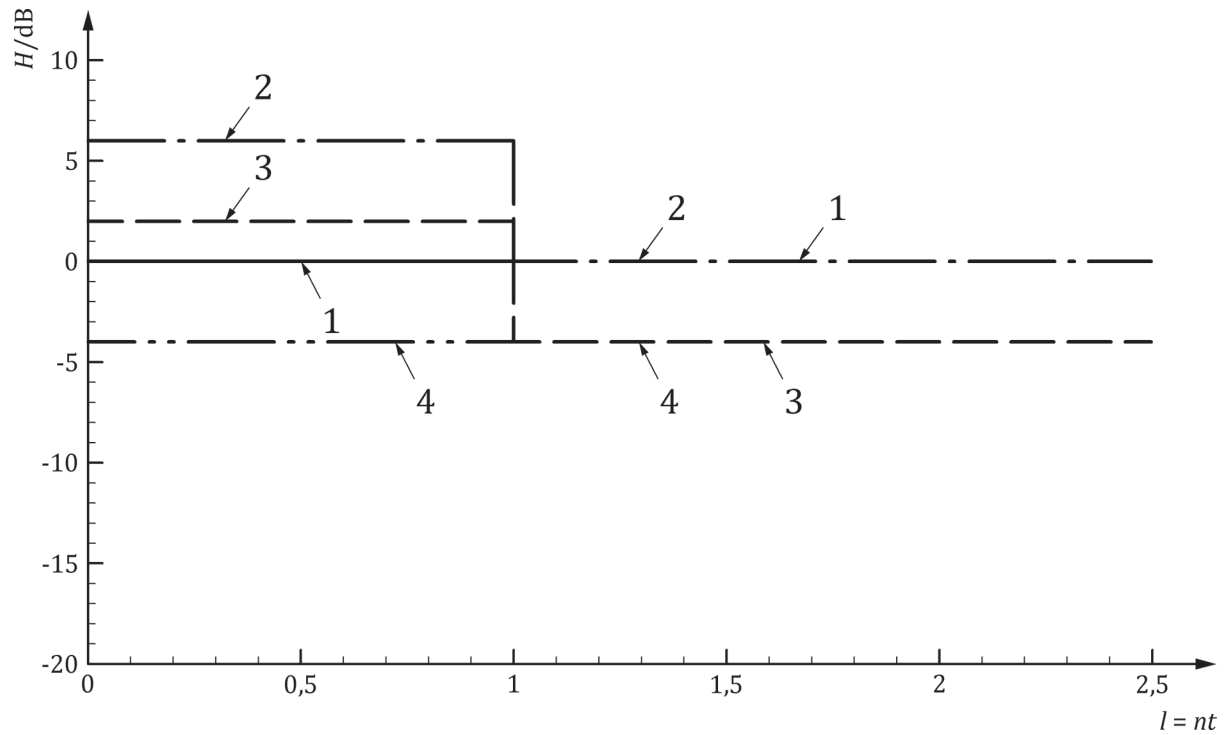
**Key**

- 1 reference level
- 2 acceptance level 3
- 3 recording level
- 4 evaluation level
- H amplitude
- l length of discontinuities
- n multiplier of t
- t thickness

Figure A.6 — Levels for technique 2 for thicknesses 8 mm to 15 mm — Acceptance level 3

ISO 11666:2018(E)

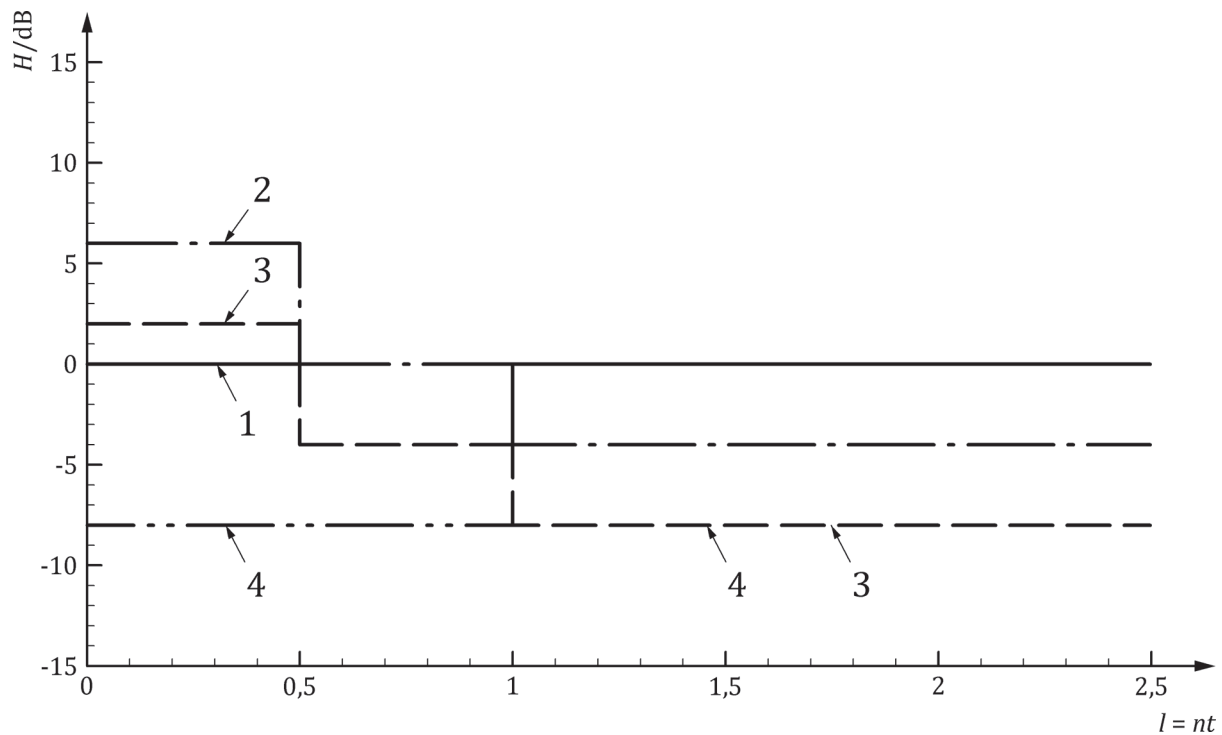
**Key**

- 1 reference level
- 2 acceptance level 2
- 3 recording level
- 4 evaluation level
- H amplitude
- l length of discontinuities
- n multiplier of t
- t thickness

Figure A.7 — Levels for technique 2 for thicknesses 15 mm to 100 mm — Acceptance level 2

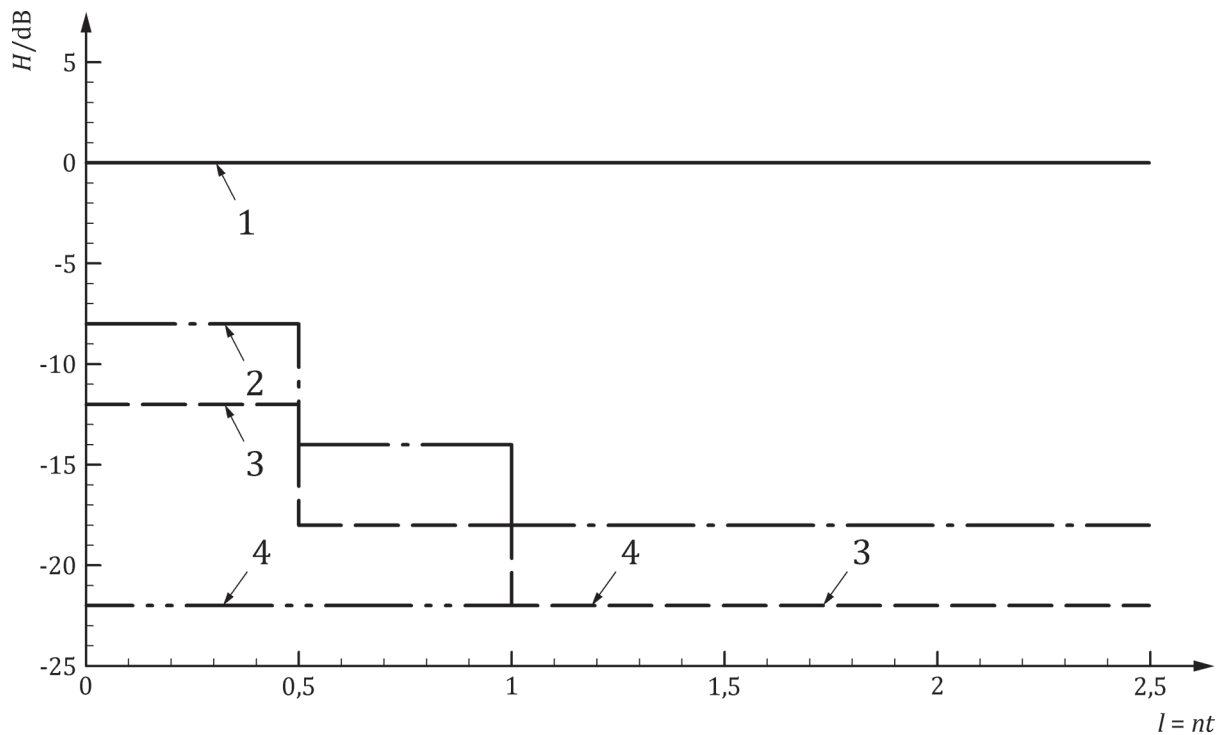
**Key**

- 1 reference level
- 2 acceptance level 2
- 3 recording level
- 4 evaluation level
- H amplitude
- l length of discontinuities
- n multiplier of t
- t thickness

Figure A.8 — Levels for technique 4 for thicknesses 15 mm to 100 mm — Acceptance level 2

ISO 11666:2018(E)

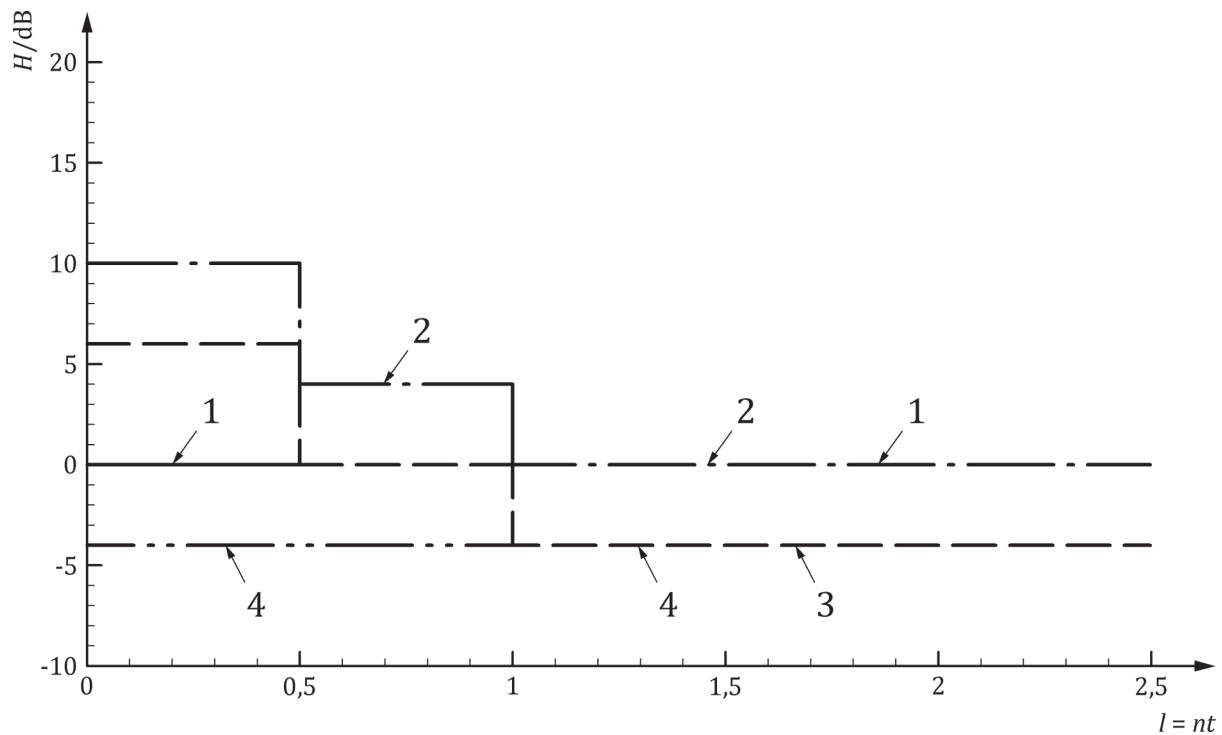
**Key**

- 1 reference level
- 2 acceptance level 3
- 3 recording level
- 4 evaluation level
- H amplitude
- l length discontinuities
- n multiplier of t
- t thickness

Figure A.9 — Levels for technique 2 for thicknesses 15 mm to 100 mm — Acceptance level 3

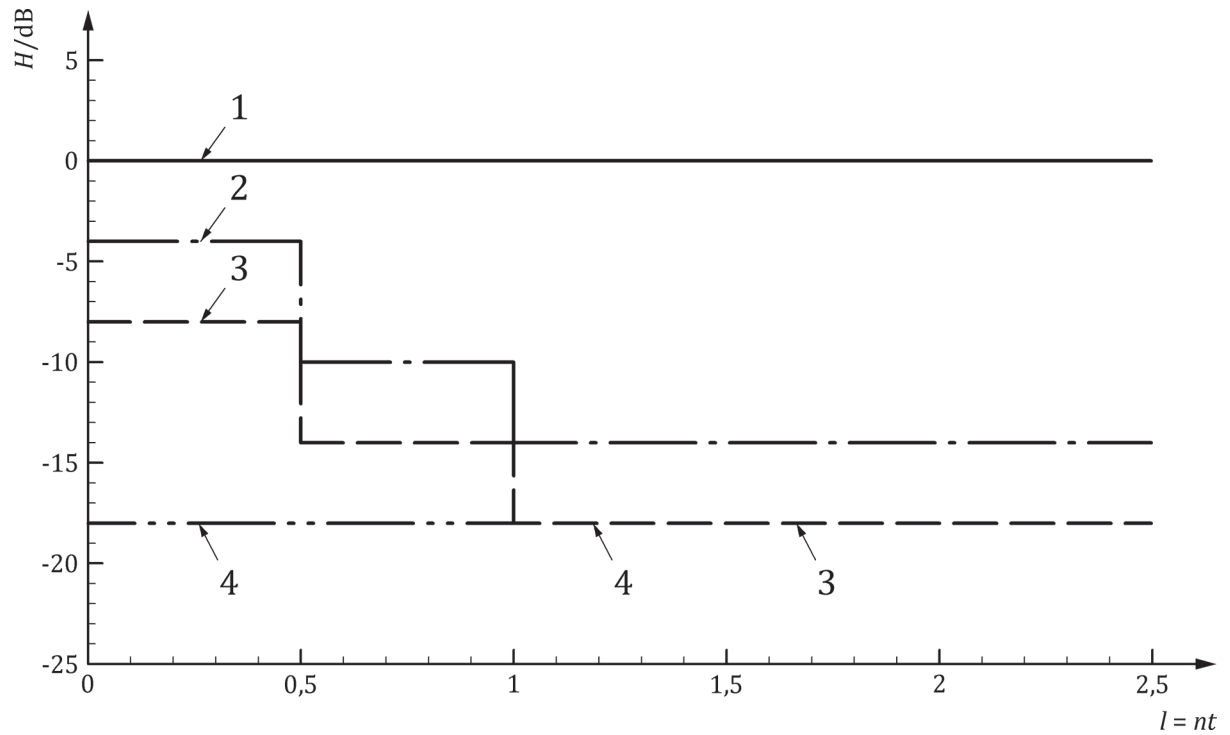
**Key**

- 1 reference level
- 2 acceptance level 3
- 3 recording level
- 4 evaluation level
- H amplitude
- l length of discontinuities
- n multiplier of t
- t thickness

Figure A.10 — Levels for technique 4 for thicknesses 15 mm to 100 mm — Acceptance level 3

ISO 11666:2018(E)

Table A.1 — Acceptance levels 2 (AL 2) and 3 (AL 3) for techniques 1, 2, 3 and 4

Technique (according to ISO 17640)	Evaluation level		Acceptance level 2 (AL 2)		Acceptance level 3 (AL 3)	
	for AL 2	for AL 3	8 mm ≤ t < 15 mm	15 mm ≤ t < 100 mm	8 mm ≤ t < 15 mm	15 mm ≤ t < 100 mm
1 (side-drilled holes)	$H_0 - 14$ dB	$H_0 - 10$ dB	For $l \leq t$: $H_0 - 4$ dB For $l > t$: $H_0 - 10$ dB	For $l \leq 0,5 t$: H_0 For $0,5 t < l \leq t$: $H_0 - 6$ dB For $l > t$: $H_0 - 10$ dB	For $l \leq t$: H_0 For $l > t$: $H_0 - 6$ dB	For $l \leq 0,5 t$: $H_0 + 4$ dB For $0,5 t < l \leq t$: $H_0 - 2$ dB For $l > t$: $H_0 - 6$ dB
2 [flat-bot- tomed holes (disk-shaped reflectors)]	$H_0 - 8$ dB in accordance with Table A.2 or A.3	$H_0 - 4$ dB in accordance with Table A.2 or A.3	For $l \leq t$: $H_0 + 2$ dB For $l > t$: $H_0 - 4$ dB	For $l \leq 0,5 t$: $H_0 + 6$ dB For $0,5 t < l \leq t$: H_0 For $l > t$: $H_0 - 4$ dB	For $l \leq t$: $H_0 + 6$ dB For $l > t$: H_0	For $l \leq 0,5 t$: $H_0 + 10$ dB For $0,5 t < l \leq t$: $H_0 + 4$ dB For $l > t$: H_0
3 (rectangular notch)	$H_0 - 14$ dB	$H_0 - 10$ dB	For $l \leq t$: $H_0 - 4$ dB For $l > t$: $H_0 - 10$ dB	—	For $l \leq t$: H_0 For $l > t$: $H_0 - 6$ dB	—
4 (tandem technique)	$H_0 - 22$ dB	$H_0 - 18$ dB	—	For $l \leq 0,5 t$: $H_0 - 8$ dB For $0,5 t < l \leq t$: $H_0 - 14$ dB For $l > t$: $H_0 - 18$ dB	—	For $l \leq 0,5 t$: $H_0 - 4$ dB For $0,5 t < l \leq t$: $H_0 - 10$ dB For $l > t$: $H_0 - 14$ dB

NOTE 1 Recording levels are 4 dB below the corresponding acceptance levels.
NOTE 2 H_0 is the reference level.

Table A.2 — Reference levels for acceptance levels 2 (AL 2) and 3 (AL 3) for technique 2 using angle-beam scanning with transverse waves

Nominal probe frequency MHz	Thickness of parent material, t					
	8 mm ≤ t < 15 mm		15 mm ≤ t < 40 mm		40 mm ≤ t < 100 mm	
	AL 2	AL 3	AL 2	AL 3	AL 2	AL 3
1,5 to 2,5	—	—	$D_{\text{DSR}} = 2,5$ mm	$D_{\text{DSR}} = 2,5$ mm	$D_{\text{DSR}} = 3,0$ mm	$D_{\text{DSR}} = 3,0$ mm
3,0 to 5,0	$D_{\text{DSR}} = 1,5$ mm	$D_{\text{DSR}} = 1,5$ mm	$D_{\text{DSR}} = 2,0$ mm	$D_{\text{DSR}} = 2,0$ mm	$D_{\text{DSR}} = 3,0$ mm	$D_{\text{DSR}} = 3,0$ mm

NOTE D_{DSR} is the diameter of the disk-shaped reflector.

Table A.3 — Reference levels for acceptance levels 2 (AL 2) and 3 (AL 3) for technique 2 using straight-beam scanning with longitudinal waves

Nominal probe frequency MHz	Thickness of parent material, t					
	8 mm ≤ t < 15 mm		15 mm ≤ t < 40 mm		40 mm ≤ t < 100 mm	
	AL 2	AL 3	AL 2	AL 3	AL 2	AL 3
1,5 to 2,5	—	—	$D_{\text{DSR}} = 2,5$ mm	$D_{\text{DSR}} = 2,5$ mm	$D_{\text{DSR}} = 3,0$ mm	$D_{\text{DSR}} = 3,0$ mm
3,0 to 5,0	$D_{\text{DSR}} = 2,0$ mm	$D_{\text{DSR}} = 2,0$ mm	$D_{\text{DSR}} = 2,0$ mm	$D_{\text{DSR}} = 2,0$ mm	$D_{\text{DSR}} = 3,0$ mm	$D_{\text{DSR}} = 3,0$ mm

NOTE D_{DSR} is the diameter of the disk-shaped reflector.

Annex B (normative)

Fixed-amplitude level technique

The technique determines the lateral dimensions of a discontinuity over which the echo is equal to or greater than the evaluation level.

To make a measurement, the beam is scanned over the discontinuities, and the probe position and beam path range, at which the echo has fallen to the evaluation level, are noted (see [Figure B.1](#)).

The lateral dimension, l , is then determined by the distance between the positions 1 and 2.

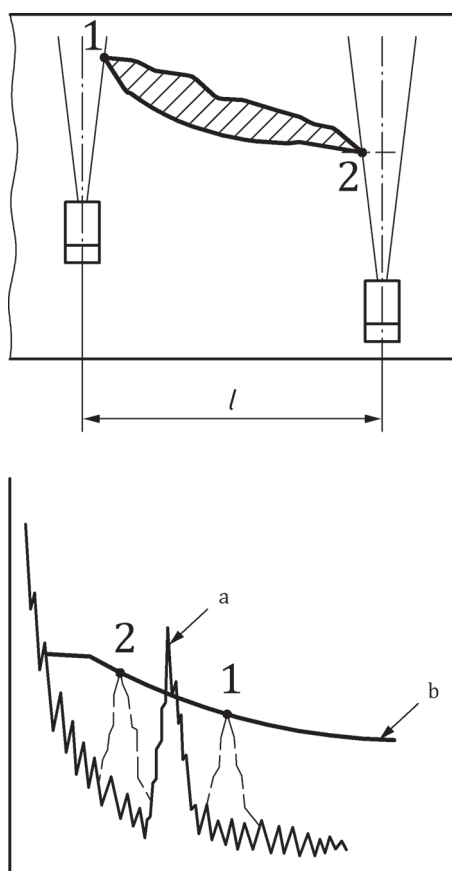

Key

- l measured lateral dimension of discontinuity
- 1, 2 positions where the indication amplitudes are equal to the evaluation level
- a Maximum echo.
- b Evaluation level.

Figure B.1 — Fixed-amplitude-level technique using the beam axis

ISO 11666:2018(E)

ICS 25.160.40

Price based on 17 pages

© ISO 2018 – All rights reserved