



P O L S K A N O R M A

ICS 25.160.40

PN-EN ISO 23279

Wprowadza

EN ISO 23279:2017, IDT

ISO 23279:2017, IDT

Zastępuje

PN-EN ISO 23279:2010

Badania nieniszczące spoin

Badania ultradźwiękowe

Charakterystyka nieciągłości w spoinach

Norma Europejska EN ISO 23279:2017 *Non-destructive testing of welds – Ultrasonic testing – Characterization of discontinuities in welds (ISO 23279:2017)* ma status Polskiej Normy

© Copyright by PKN, Warszawa 2017

nr ref. PN-EN ISO 23279:2017-11

Wszelkie prawa autorskie zastrzeżone. Żadna część niniejszej publikacji nie może być zwielokrotniana jakkolwiek techniką bez pisemnej zgody Prezesa Polskiego Komitetu Normalizacyjnego

ISBN 978-83-275-8629-2

PN-EN ISO 23279:2017-11

Przedmowa krajowa

Niniejsza norma została zatwierdzona przez Prezesa PKN dnia 7 listopada 2017 r.

Komitetem krajowym odpowiedzialnym za normę jest KT nr 165 ds. Spawania i Procesów Pokrewnych.

Istnieje możliwość przetłumaczenia normy na język polski na wniosek zainteresowanych środowisk. Decyzję podejmuje właściwy Komitet Techniczny.

Niniejsza norma zastępuje PN-EN ISO 23279:2010.

Odpowiedniki krajowe norm i innych dokumentów powołanych w niniejszej normie można znaleźć w katalogu Polskich Norm. Oryginały norm i innych dokumentów powołanych są dostępne w PKN.

W sprawach merytorycznych dotyczących treści normy można zwracać się do właściwego Komitetu Technicznego lub właściwej Rady Sektorowej PKN, kontakt: www.pkn.pl

Nota uznaniowa

Norma Europejska EN ISO 23279:2017 została uznana przez PKN za Polską Normę PN-EN ISO 23279:2017-11.

EUROPEAN STANDARD

EN ISO 23279

NORME EUROPÉENNE

EUROPÄISCHE NORM

September 2017

ICS 25.160.40

Supersedes EN ISO 23279:2010

English Version

**Non-destructive testing of welds - Ultrasonic testing -
Characterization of discontinuities in welds (ISO
23279:2017)**

Essais non destructifs des assemblages soudés -
Contrôle par ultrasons - Caractérisation des
discontinuités dans les assemblages soudés (ISO
23279:2017)

Zerstörungsfreie Prüfung von Schweißverbindungen -
Ultraschallprüfung - Charakterisierung von
Inhomogenitäten in Schweißnähten (ISO 23279:2017)

This European Standard was approved by CEN on 4 June 2017.

CEN members are bound to comply with the CEN/CENELEC Internal Regulations which stipulate the conditions for giving this European Standard the status of a national standard without any alteration. Up-to-date lists and bibliographical references concerning such national standards may be obtained on application to the CEN-CENELEC Management Centre or to any CEN member.

This European Standard exists in three official versions (English, French, German). A version in any other language made by translation under the responsibility of a CEN member into its own language and notified to the CEN-CENELEC Management Centre has the same status as the official versions.

CEN members are the national standards bodies of Austria, Belgium, Bulgaria, Croatia, Cyprus, Czech Republic, Denmark, Estonia, Finland, Former Yugoslav Republic of Macedonia, France, Germany, Greece, Hungary, Iceland, Ireland, Italy, Latvia, Lithuania, Luxembourg, Malta, Netherlands, Norway, Poland, Portugal, Romania, Serbia, Slovakia, Slovenia, Spain, Sweden, Switzerland, Turkey and United Kingdom.



EUROPEAN COMMITTEE FOR STANDARDIZATION
COMITÉ EUROPÉEN DE NORMALISATION
EUROPÄISCHES KOMITEE FÜR NORMUNG

CEN-CENELEC Management Centre: Avenue Marnix 17, B-1000 Brussels

EN ISO 23279:2017 (E)

Contents	Page
European foreword.....	3

European foreword

This document (EN ISO 23279:2017) has been prepared by Technical Committee ISO/TC 44 “Welding and allied processes” in collaboration with Technical Committee CEN/TC 121 “Welding and allied processes” the secretariat of which is held by DIN.

This European Standard shall be given the status of a national standard, either by publication of an identical text or by endorsement, at the latest by March 2018, and conflicting national standards shall be withdrawn at the latest by March 2018.

Attention is drawn to the possibility that some of the elements of this document may be the subject of patent rights. CEN shall not be held responsible for identifying any or all such patent rights.

This document supersedes EN ISO 23279:2010.

According to the CEN-CENELEC Internal Regulations, the national standards organizations of the following countries are bound to implement this European Standard: Austria, Belgium, Bulgaria, Croatia, Cyprus, Czech Republic, Denmark, Estonia, Finland, Former Yugoslav Republic of Macedonia, France, Germany, Greece, Hungary, Iceland, Ireland, Italy, Latvia, Lithuania, Luxembourg, Malta, Netherlands, Norway, Poland, Portugal, Romania, Serbia, Slovakia, Slovenia, Spain, Sweden, Switzerland, Turkey and the United Kingdom.

Endorsement notice

The text of ISO 23279:2017 has been approved by CEN as EN ISO 23279:2017 without any modification.

INTERNATIONAL
STANDARD

ISO
23279

Third edition
2017-08

**Non-destructive testing of welds —
Ultrasonic testing — Characterization
of discontinuities in welds**

*Essais non destructifs des assemblages soudés — Contrôle par
ultrasons — Caractérisation des discontinuités dans les assemblages
soudés*



Reference number
ISO 23279:2017(E)

© ISO 2017

ISO 23279:2017(E)



COPYRIGHT PROTECTED DOCUMENT

© ISO 2017, Published in Switzerland

All rights reserved. Unless otherwise specified, no part of this publication may be reproduced or utilized otherwise in any form or by any means, electronic or mechanical, including photocopying, or posting on the internet or an intranet, without prior written permission. Permission can be requested from either ISO at the address below or ISO's member body in the country of the requester.

ISO copyright office
Ch. de Blandonnet 8 • CP 401
CH-1214 Vernier, Geneva, Switzerland
Tel. +41 22 749 01 11
Fax +41 22 749 09 47
copyright@iso.org
www.iso.org

Contents

	Page
Foreword	iv
1 Scope	1
2 Normative references	1
3 Terms and definitions	1
4 Principle	1
5 Criteria	2
5.1 General.....	2
5.2 Echo amplitude criteria (stages 1 and 2).....	3
5.2.1 Low amplitudes (stage 1).....	3
5.2.2 High amplitudes (stage 2).....	3
5.3 Directional reflectivity criteria (stage 3).....	3
5.3.1 Applicability based on length.....	3
5.3.2 Application conditions.....	3
5.3.3 Criteria.....	3
5.4 Echo static pattern criteria (stage 4).....	4
5.5 Transverse echo dynamic pattern criteria (stage 5).....	4
5.6 Complementary testing.....	4
Annex A (normative) Classification of indications from internal discontinuities in welds — Flowchart procedure	5
Annex B (informative) Directional reflectivity	8
Annex C (informative) Basic echo dynamic patterns of reflectors	10

ISO 23279:2017(E)

Foreword

ISO (the International Organization for Standardization) is a worldwide federation of national standards bodies (ISO member bodies). The work of preparing International Standards is normally carried out through ISO technical committees. Each member body interested in a subject for which a technical committee has been established has the right to be represented on that committee. International organizations, governmental and non-governmental, in liaison with ISO, also take part in the work. ISO collaborates closely with the International Electrotechnical Commission (IEC) on all matters of electrotechnical standardization.

The procedures used to develop this document and those intended for its further maintenance are described in the ISO/IEC Directives, Part 1. In particular the different approval criteria needed for the different types of ISO documents should be noted. This document was drafted in accordance with the editorial rules of the ISO/IEC Directives, Part 2 (see www.iso.org/directives).

Attention is drawn to the possibility that some of the elements of this document may be the subject of patent rights. ISO shall not be held responsible for identifying any or all such patent rights. Details of any patent rights identified during the development of the document will be in the Introduction and/or on the ISO list of patent declarations received (see www.iso.org/patents).

Any trade name used in this document is information given for the convenience of users and does not constitute an endorsement.

For an explanation on the voluntary nature of standards, the meaning of ISO specific terms and expressions related to conformity assessment, as well as information about ISO's adherence to the World Trade Organization (WTO) principles in the Technical Barriers to Trade (TBT) see the following URL: www.iso.org/iso/foreword.html.

This document was prepared by Technical Committee ISO/TC 44, *Welding and allied processes*, Subcommittee SC 5, *Testing and inspection of welds*.

This third edition cancels and replaces the second edition (ISO 23279:2010), which has been technically revised.

Requests for official interpretations of any aspect of this document should be directed to the Secretariat of ISO/TC 44/SC 5 via your national standards body. A complete listing of these bodies can be found at www.iso.org.

Non-destructive testing of welds — Ultrasonic testing — Characterization of discontinuities in welds

1 Scope

This document specifies how to characterize indications from discontinuities by classifying them as originating from planar or non-planar embedded discontinuities.

This procedure is also suitable for indications from discontinuities that break the surface after removal of the weld reinforcement.

2 Normative references

The following documents are referred to in the text in such a way that some or all of their content constitutes requirements of this document. For dated references, only the edition cited applies. For undated references, the latest edition of the referenced document (including any amendments) applies.

ISO 11666, *Non-destructive testing of welds — Ultrasonic testing — Acceptance levels*

ISO 17640, *Non-destructive testing of welds — Ultrasonic testing — Techniques, testing levels, and assessment*

3 Terms and definitions

No terms and definitions are listed in this document.

ISO and IEC maintain terminological databases for use in standardization at the following addresses:

- IEC Electropedia: available at <http://www.electropedia.org/>
- ISO Online browsing platform: available at <http://www.iso.org/obp>

4 Principle

Classification of discontinuities as planar or non-planar is based on several parameters:

- a) welding techniques;
- b) geometrical position of the discontinuity;
- c) maximum echo amplitude;
- d) directional reflectivity;
- e) echo static pattern (i.e. A-scan);
- f) echo dynamic pattern (envelope).

The process of classification involves examining each of the parameters against all the others in order to arrive at an accurate conclusion.

For guidance, [Figure A.1](#) gives the classification of indications from internal weld discontinuities suitable for general applications. [Figure A.1](#) should be applied in conjunction with the two parameters a) and b) listed above and not taken in isolation.

ISO 23279:2017(E)

The classification procedure specified in this document is also suitable for indications that come from surface breaking discontinuities after removal of the weld reinforcement (see [Figure 1](#)).

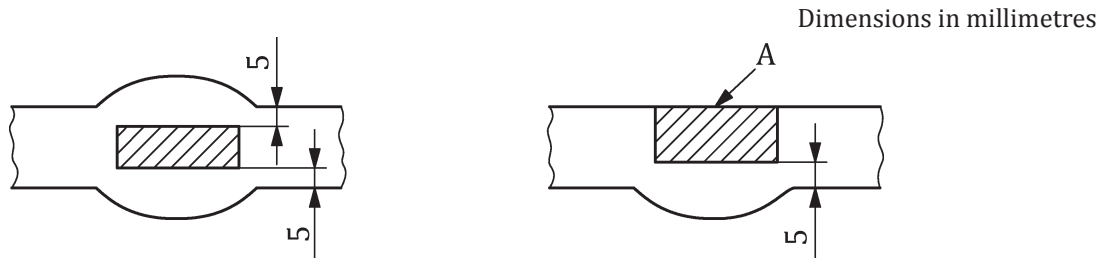

Key

A ground weld

Figure 1 — Origin of indications from a weld

5 Criteria

5.1 General

The classification is carried out by the successive application of several discriminatory criteria to:

- a) echo amplitude;
- b) directional reflectivity;
- c) echo static pattern (A-scan);
- d) echo dynamic pattern (envelope).

These criteria shall be applied using the flowchart procedure according to [Annex A](#) and as described in [Clause 5](#).

It is recommended that the same probes be used for detection and for classification of discontinuities. The flowchart procedure standardizes a system of classification. Several thresholds are defined in decibels by a comparison with the distance-amplitude curve (DAC) or by a comparison of the maximum echo heights from the discontinuity when tested from different directions.

Proposed thresholds for the different stages in the flowchart procedure are given in [Table A.1](#).

The flowchart procedure calls for five stages:

- stage 1: to avoid the classification of indications with very low echo amplitudes;
- stage 2: to classify all indications with high echo amplitude as associated with planar discontinuities;
- stage 3: primarily to classify lack of fusion;
- stage 4: primarily to classify inclusions;
- stage 5: primarily to classify cracks.

NOTE Indications resulting from a combination of an inclusion and lack of fusion are classified as originating from a planar discontinuity by the flowchart procedure. An example of this type of discontinuity is given in [Figure A.2](#).

5.2 Echo amplitude criteria (stages 1 and 2)

5.2.1 Low amplitudes (stage 1)

It is accepted that an indication with an echo amplitude lower than the evaluation level as specified in ISO 11666 (defined as T_1 in [Figure A.1](#)) is not significant and shall not be characterized.

For special applications, this value, T_1 , may be lowered, if defined by specification.

5.2.2 High amplitudes (stage 2)

It is assumed that an indication with an echo amplitude that is at least equal to the reference level plus 6 dB (defined as T_2 in [Figure A.1](#)) is associated with a planar discontinuity.

5.3 Directional reflectivity criteria (stage 3)

5.3.1 Applicability based on length

Stage 3 of the flowchart procedure shall be applied only to those indications exceeding:

- a) thickness t for the range $8 \text{ mm} \leq t \leq 15 \text{ mm}$;
- b) $t/2$ or 15 mm, whichever is larger, for thicknesses over 15 mm.

For indications not exceeding the specified length, proceed to stage 4.

5.3.2 Application conditions

The following application conditions apply:

- a) Echoes compared shall be obtained from the same reflector.
- b) The comparison shall be made at the position where echo height, $H_{d, \max}$, is the highest along the indication.
- c) When a normal-beam probe and an angle-beam probe are used, their frequencies shall be chosen to give similar wavelengths (e.g. 4 MHz for longitudinal waves and 2 MHz for transverse waves for steel).
- d) When two or more beam angles are used, the differences between the nominal refracted beam angles shall be equal to or greater than 10° .
- e) If the comparison is made between a beam passing through the weld and a beam passing through the base material only, the attenuation of the weld material shall be taken into account.

5.3.3 Criteria

The highest echo amplitude, $H_{d, \max}$, obtained from the discontinuity is compared with the minimum echo amplitude, $H_{d, \min}$, obtained from all the other directions.

To satisfy the directional reflectivity, the following conditions shall be fulfilled simultaneously:

- a) $H_{d, \max}$ is greater than or equal to T_3 (the reference level – 6 dB).
- b) The modulus of the difference of the amplitudes of the indications, $|H_{d, \max} - H_{d, \min}|$, from two different directions is at least
 - 1) 9 dB using transverse wave angle-beam probes only, or
 - 2) 15 dB using one transverse wave angle-beam probe and one longitudinal wave normal-beam probe.

ISO 23279:2017(E)

The directional reflectivities depend on the angle of refraction and the test conditions (half skip, full skip).

Examples of different testing directions are given in [Figure B.1](#).

An example of the application of these criteria is given in [Figure B.2](#).

5.4 Echo static pattern criteria (stage 4)

At this stage, the echo static pattern (i.e. A-scan) of the discontinuity is compared with that obtained from the reference reflector (3 mm diameter side-drilled hole).

If the echo static pattern is single and smooth, the discontinuity is classified as non-planar.

If the echo static pattern is not both single and smooth, proceed to stage 5.

These criteria shall be fulfilled for at least two directions of testing.

5.5 Transverse echo dynamic pattern criteria (stage 5)

The transverse echo dynamic pattern of a discontinuity is the envelope of the resulting echoes when the ultrasonic probe is moved perpendicular to the discontinuity in accordance with ISO 17640. The analysis takes into account not only the envelope, but also the behaviour of the echoes inside of it.

Classification of discontinuities depends on the patterns observed:

- pattern 1: single, non-planar discontinuity;
- pattern 2: excluded by previous stage;
- pattern 3 and pattern 4: planar discontinuity, if observed for the two directions of highest reflectivity; if only observed for one reflectivity direction, use complementary tests (see [5.6](#));
- pattern 5: cluster of non-planar discontinuities.

These patterns used for classification are given in [Annex C](#).

These criteria shall be fulfilled for at least two directions of testing.

5.6 Complementary testing

In case of doubt, carry out additional tests, for example:

- a) use of additional reflectivity directions or additional probes;
- b) analysis of the echo dynamic pattern when the probe is moved parallel to the discontinuity [see [Figure C.1 c](#)), [Figure C.2 c](#)), [Figure C.3 c](#)), [Figure C.4 c](#)) and [Figure C.5 c](#))];
- c) other non-destructive testing methods (e.g. radiography).

This list is not restrictive.

Annex A (normative)

Classification of indications from internal discontinuities in welds — Flowchart procedure

The flowchart procedure is defined in [Figure A.1](#).

ISO 23279:2017(E)

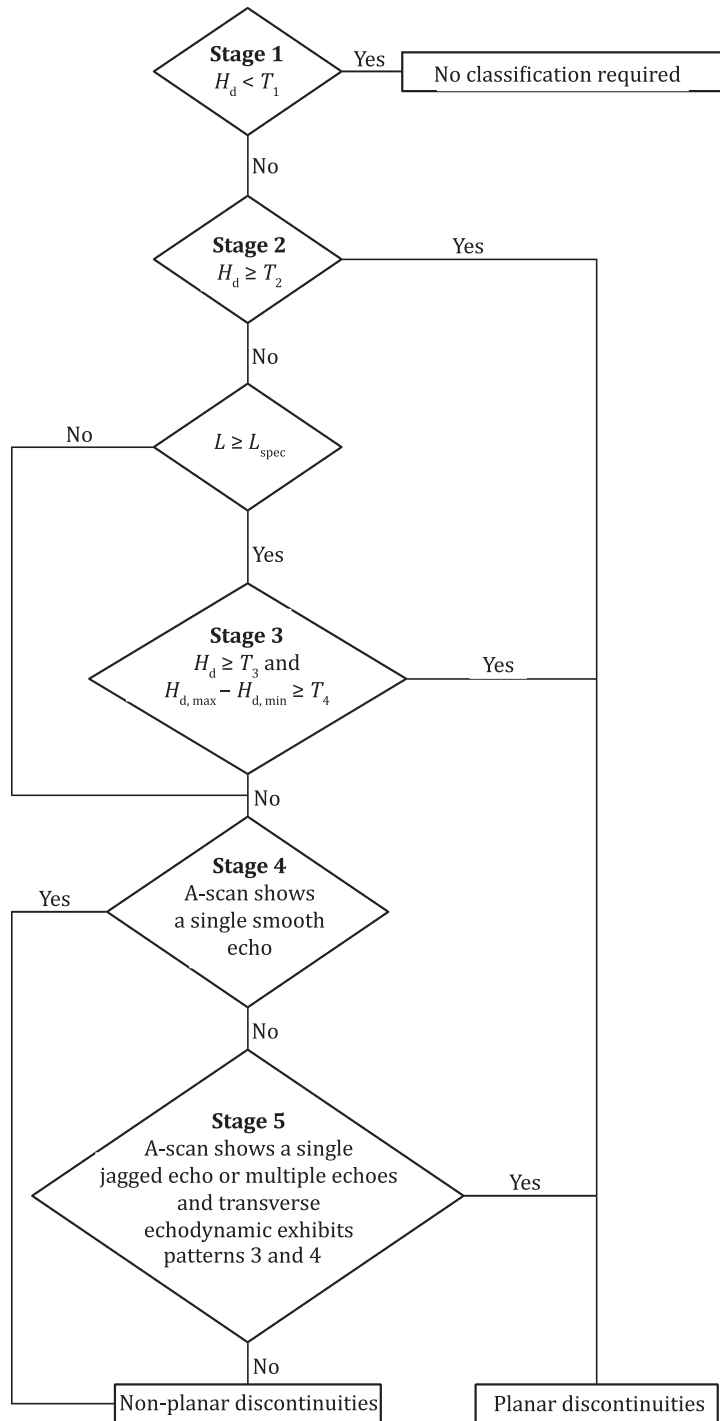
**Key**

H_d	indication echo amplitude
$H_{d,max}$	maximum echo amplitude
$H_{d,min}$	minimum echo amplitude
L	length
L_{spec}	specified length
T_1, T_2, T_3, T_4	see Table A.1

Figure A.1 — Flowchart procedure

Table A.1 — Different thresholds used in the flowchart procedure

Threshold	T_1	T_2	T_3	T_4
Threshold values	Evaluation level	Reference level + 6 dB	Reference level – 6 dB	9 dB ^a or 15 dB ^b
^a	For transverse waves.			
^b	Between reflections obtained with transverse waves and longitudinal waves.			

Stage 1 (T_1 , i.e. evaluation level): All indications $< T_1$ are not classified.

Stage 2 (T_2 , i.e. reference level + 6 dB): An indication being at least twice as reflective as the reference reflector is classified as associated with a planar discontinuity.

Stage 3 (T_3 , i.e. reference level – 6 dB): If the echo amplitude of the indication is at least half of the reference echo and, if the imbalance in reflectivity is greater than or equal to T_4 , the indication is classified as associated with a planar discontinuity:

- with $T_4 = 9$ dB for transverse waves;
- with $T_4 = 15$ dB between reflections obtained with transverse waves and with longitudinal waves.

The angles at which the ultrasonic beam is incident upon the discontinuity shall have a difference of at least 10° . The comparison shall be made upon the same area of the discontinuity.

Stages 4 and 5: These criteria shall be fulfilled for at least two directions of testing.

Stage 5: If the echo dynamic pattern does not match pattern 3, the indication is classified as associated with a non-planar discontinuity.

The echo patterns are those defined in [Annex C](#).

Indications resulting from a combination of an inclusion and lack of fusion are classified as associated with a planar discontinuity by the flowchart procedure. An example of this type of discontinuity is given in [Figure A.2](#).

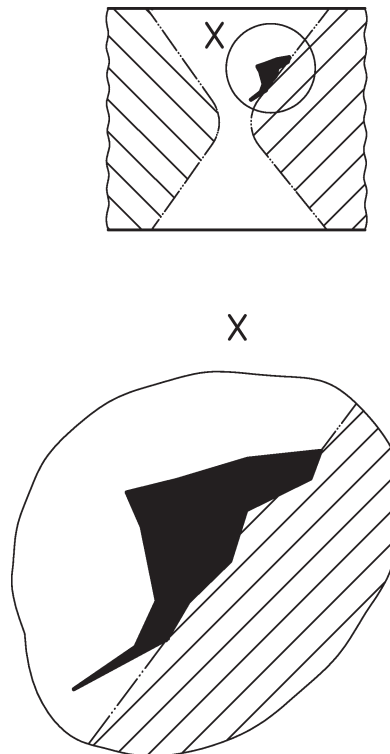
**Figure A.2 — Example of a combination of inclusion and lack of fusion**

Annex B (informative)

Directional reflectivity

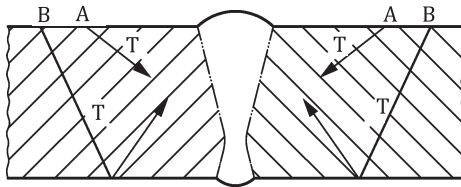

a) Transverse waves, T

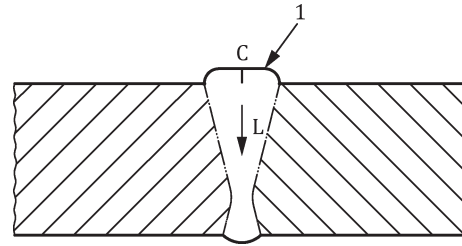

b) Longitudinal waves, L

Key

- A, B, C probe positions
- L longitudinal waves
- T transverse waves
- 1 local grinding

Figure B.1 — Examples of testing directions

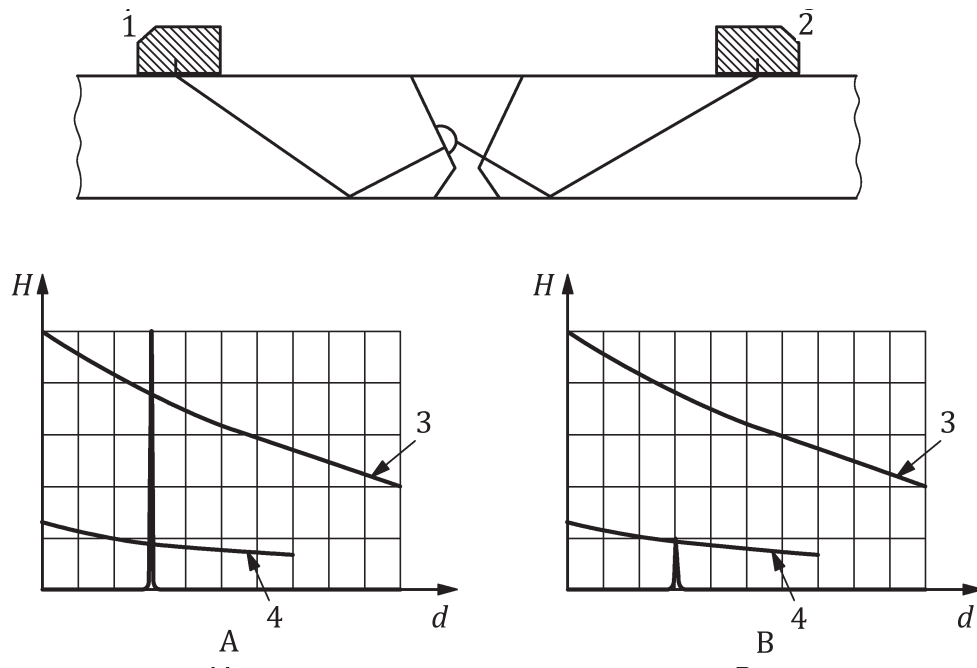
**Key**

- A display when using position 1
- B display when using position 2
- 1 position 1
- 2 position 2
- 3 reference level
- 4 reference level - 9 dB
- d sound path
- H amplitude

Figure B.2 — Example of application of directional reflectivity criteria

Annex C (informative)

Basic echo dynamic patterns of reflectors

C.1 Pattern 1

A point-like reflector response is shown in [Figure C.1](#). At any probe position, the A-scan shows a single sharp echo. As the probe is moved, it rises in amplitude smoothly to a single maximum before falling smoothly to noise level.

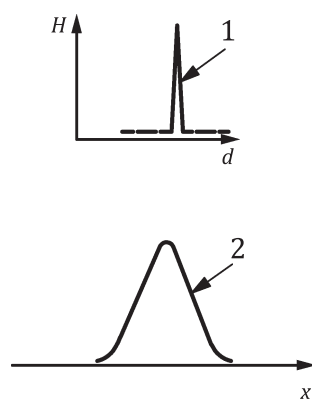

a) Probe position of A-scan and variation in signal amplitude

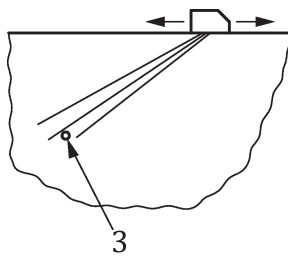

b) Typical occurrence in through-thickness direction

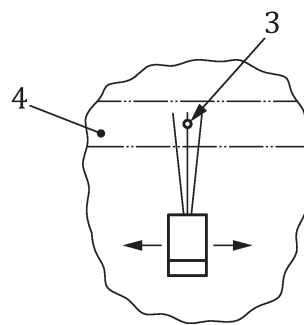

c) Typical occurrence in lateral (length) direction

Key

- 1 A-scan
- 2 variation in signal peak amplitude
- 3 reflector
- 4 weld
- d range
- H amplitude
- x probe position

Figure C.1 — Pattern 1 ultrasonic response

C.2 Pattern 2

An extended smooth reflector response is shown in [Figure C.2](#). At any probe position, the A-scan shows a single sharp echo. When the ultrasonic beam is moved over the reflector, the echo rises smoothly to a plateau and is maintained, with minor variations in amplitude of up to 4 dB, until the beam moves off the reflector, when the echo falls smoothly to noise level.

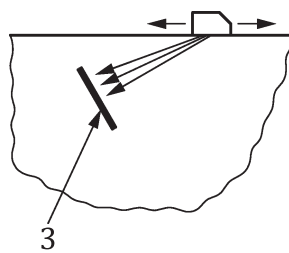
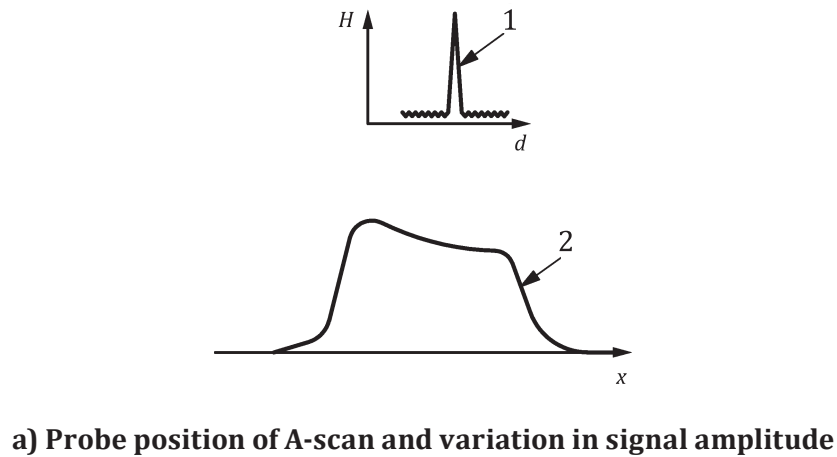

b) Typical occurrence in through-thickness direction

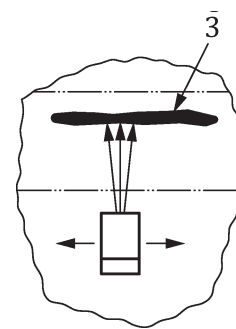

c) Typical occurrence in lateral (length) direction

Key

- 1 A-scan
- 2 variation in signal peak amplitude
- 3 reflector
- d range
- H amplitude
- x probe position

Figure C.2 — Pattern 2 ultrasonic response

ISO 23279:2017(E)

C.3 Pattern 3

There are two variants of an extended rough reflector response depending upon the angle of incidence of the beam on the reflector.

One variant, at near normal incidence, is shown in [Figure C.3](#). At any probe position, the A-scan shows a single but ragged echo. As the probe is moved, this may undergo large (greater than ± 6 dB) random fluctuations in amplitude. The fluctuations are caused by reflection from different facets of the reflector and by random interference of waves scattered from groups of facets.

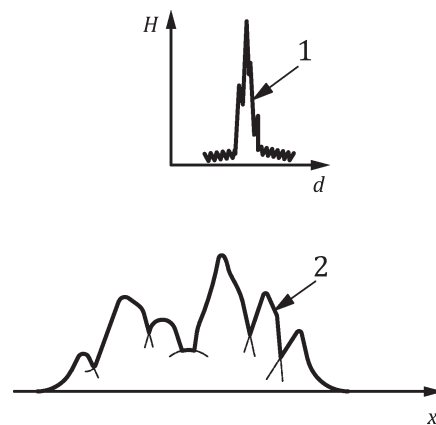

a) Probe position of A-scan and variation in signal amplitude

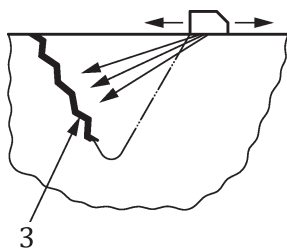

b) Typical occurrence in through-thickness direction

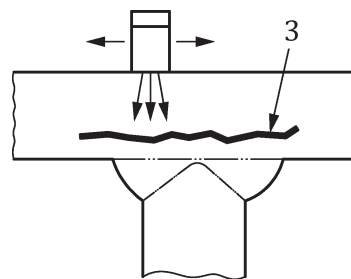

c) Typical occurrence in lateral (length) direction

Key

- 1 A-scan
- 2 variation in signal peak amplitude
- 3 reflector
- d range
- H amplitude
- x probe position

Figure C.3 — Pattern 3 ultrasonic response

C.4 Pattern 4

The second variant of an extended rough reflector response, oblique incidence, “travelling echo pattern”, is shown in [Figure C.4](#). At any probe position, the A-scan shows an extended train of signals (“subsidiary peaks”) within a bell-shaped pulse envelope. As the probe is moved, each subsidiary peak travels through the pulse envelope, rising to its own maximum towards the centre of the envelope and then falling. The overall signal may show large (greater than ± 6 dB) random fluctuations in amplitude.

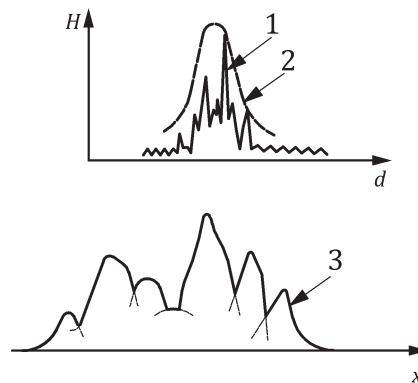

a) Probe position of A-scan and variation in signal amplitude

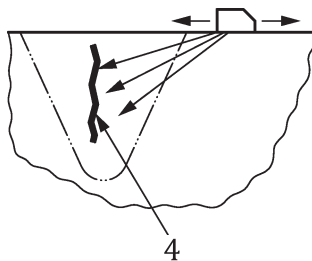

b) Typical occurrence in through-thickness direction

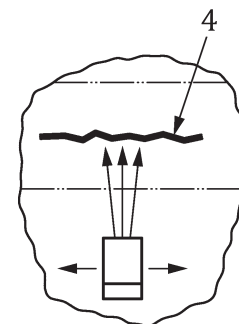

c) Typical occurrence in lateral (length) direction

Key

- 1 A-scan
- 2 pulse envelope
- 3 variation in signal peak amplitude
- 4 reflector
- d range
- H amplitude
- x probe position

Figure C.4 — Pattern 4 ultrasonic response

ISO 23279:2017(E)

C.5 Pattern 5

A multiple reflector response is shown in [Figure C.5](#). At any probe position, the A-scan shows a cluster of signals which may or may not be well-resolved in range. As the probe is moved, the signals rise and fall at random, but the signal from each separate reflector element, if resolved, shows a pattern 1 response.

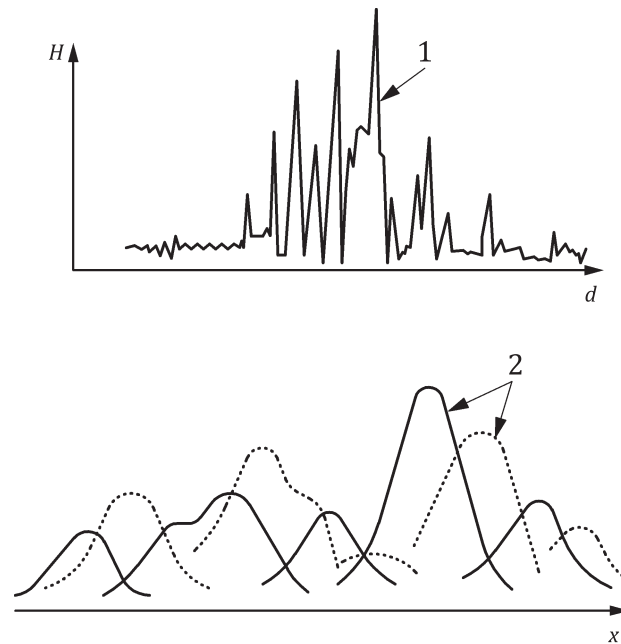

a) Probe position of A-scan and variation in signal amplitude

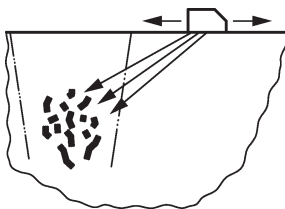

b) Typical occurrence in through-thickness direction

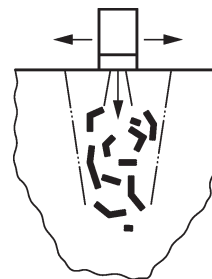

c) Typical occurrence in lateral (length) direction

Key

- 1 A-scan
- 2 variation in signal peak amplitude
- continuous lines: long-range echoes
- dotted lines: short-range echoes
- d range
- H amplitude
- x probe position

Figure C.5 — Pattern 5 ultrasonic response

ISO 23279:2017(E)

ICS 25.160.40

Price based on 14 pages

© ISO 2017 – All rights reserved