



POLSKI KOMITET
NORMALIZACYJNY

P O L S K A N O R M A

ICS 25.160.40

PN-EN ISO 17637

Wprowadza

EN ISO 17637:2016, IDT
ISO 17637:2016, IDT

Zastępuje

PN-EN ISO 17637:2011

Badania nieniszczące złączy spawanych

Badania wizualne złączy spawanych

Norma Europejska EN ISO 17637:2016 *Non-destructive testing of welds – Visual testing of fusion-welded joints (ISO 17637:2016)* ma status Polskiej Normy

© Copyright by PKN, Warszawa 2017

nr ref. PN-EN ISO 17637:2017-02

Wszelkie prawa autorskie zastrzeżone. Żadna część niniejszej publikacji nie może być zwielokrotniana jakkolwiek techniką bez pisemnej zgody Prezesa Polskiego Komitetu Normalizacyjnego

ISBN 978-83-275-7369-8

PN-EN ISO 17637:2017-02

Przedmowa krajowa

Niniejsza norma została zatwierdzona przez Prezesa PKN dnia 13 lutego 2017 r.

Komitetem krajowym odpowiedzialnym za normę jest KT nr 165 ds. Spawania i Procesów Pokrewnych.

Istnieje możliwość przetłumaczenia normy na język polski na wniosek zainteresowanych środowisk. Decyzję podejmuje właściwy Komitet Techniczny.

Niniejsza norma zastępuje PN-EN ISO 17637:2011.

W sprawach merytorycznych dotyczących treści normy można zwracać się do właściwego Komitetu Technicznego lub właściwej Rady Sektorowej PKN, kontakt: www.pkn.pl.

Nota uznaniowa

Norma Europejska EN ISO 17637:2016 została uznana przez PKN za Polską Normę PN-EN ISO 17637:2017-02.

EUROPEAN STANDARD

EN ISO 17637

NORME EUROPÉENNE

EUROPÄISCHE NORM

December 2016

ICS 25.160.40

Supersedes EN ISO 17637:2011

English Version

Non-destructive testing of welds - Visual testing of fusion-welded joints (ISO 17637:2016)

Contrôle non destructif des assemblages soudés -
Contrôle visuel des assemblages soudés par fusion (ISO
17637:2016)

Zerstörungsfreie Prüfung von Schweißverbindungen -
Sichtprüfung von Schmelzschweißverbindungen (ISO
17637:2016)

This European Standard was approved by CEN on 19 October 2016.

CEN members are bound to comply with the CEN/CENELEC Internal Regulations which stipulate the conditions for giving this European Standard the status of a national standard without any alteration. Up-to-date lists and bibliographical references concerning such national standards may be obtained on application to the CEN-CENELEC Management Centre or to any CEN member.

This European Standard exists in three official versions (English, French, German). A version in any other language made by translation under the responsibility of a CEN member into its own language and notified to the CEN-CENELEC Management Centre has the same status as the official versions.

CEN members are the national standards bodies of Austria, Belgium, Bulgaria, Croatia, Cyprus, Czech Republic, Denmark, Estonia, Finland, Former Yugoslav Republic of Macedonia, France, Germany, Greece, Hungary, Iceland, Ireland, Italy, Latvia, Lithuania, Luxembourg, Malta, Netherlands, Norway, Poland, Portugal, Romania, Slovakia, Slovenia, Spain, Sweden, Switzerland, Turkey and United Kingdom.



EUROPEAN COMMITTEE FOR STANDARDIZATION
COMITÉ EUROPÉEN DE NORMALISATION
EUROPÄISCHES KOMITEE FÜR NORMUNG

CEN-CENELEC Management Centre: Avenue Marnix 17, B-1000 Brussels

EN ISO 17637:2016 (E)

Contents	Page
European foreword.....	3

European foreword

This document (EN ISO 17637:2016) has been prepared by Technical Committee ISO/TC 44 "Welding and allied processes" in collaboration with Technical Committee CEN/TC 121 "Welding and allied processes" the secretariat of which is held by DIN.

This European Standard shall be given the status of a national standard, either by publication of an identical text or by endorsement, at the latest by June 2017, and conflicting national standards shall be withdrawn at the latest by June 2017.

Attention is drawn to the possibility that some of the elements of this document may be the subject of patent rights. CEN [and/or CENELEC] shall not be held responsible for identifying any or all such patent rights.

This document supersedes EN ISO 17637:2011.

According to the CEN-CENELEC Internal Regulations, the national standards organizations of the following countries are bound to implement this European Standard: Austria, Belgium, Bulgaria, Croatia, Cyprus, Czech Republic, Denmark, Estonia, Finland, Former Yugoslav Republic of Macedonia, France, Germany, Greece, Hungary, Iceland, Ireland, Italy, Latvia, Lithuania, Luxembourg, Malta, Netherlands, Norway, Poland, Portugal, Romania, Slovakia, Slovenia, Spain, Sweden, Switzerland, Turkey and the United Kingdom.

Endorsement notice

The text of ISO 17637:2016 has been approved by CEN as EN ISO 17637:2016 without any modification.

INTERNATIONAL STANDARD

ISO 17637

Second edition
2016-12-01

Non-destructive testing of welds — Visual testing of fusion-welded joints

*Contrôle non destructif des assemblages soudés — Contrôle visuel des
assemblages soudés par fusion*



Reference number
ISO 17637:2016(E)

© ISO 2016

ISO 17637:2016(E)



COPYRIGHT PROTECTED DOCUMENT

© ISO 2016, Published in Switzerland

All rights reserved. Unless otherwise specified, no part of this publication may be reproduced or utilized otherwise in any form or by any means, electronic or mechanical, including photocopying, or posting on the internet or an intranet, without prior written permission. Permission can be requested from either ISO at the address below or ISO's member body in the country of the requester.

ISO copyright office
Ch. de Blandonnet 8 • CP 401
CH-1214 Vernier, Geneva, Switzerland
Tel. +41 22 749 01 11
Fax +41 22 749 09 47
copyright@iso.org
www.iso.org

Contents

Page

Foreword	iv
1 Scope	1
2 Normative references	1
3 Terms and definitions	1
4 Test conditions and equipment	1
5 Personnel qualification	2
6 Visual testing	2
6.1 General.....	2
6.2 Visual testing of joint preparation.....	2
6.3 Visual testing during welding.....	2
6.4 Visual testing of the finished weld.....	3
6.4.1 General.....	3
6.4.2 Cleaning and dressing.....	3
6.4.3 Profile and dimensions.....	3
6.4.4 Weld root and surfaces.....	3
6.4.5 Post-weld heat treatment.....	4
6.5 Visual testing of repaired welds.....	4
6.5.1 General.....	4
6.5.2 Partially removed weld.....	4
6.5.3 Completely removed weld.....	4
7 Test records	4
Annex A (informative) Examples of test equipment	6
Bibliography	10

ISO 17637:2016(E)

Foreword

ISO (the International Organization for Standardization) is a worldwide federation of national standards bodies (ISO member bodies). The work of preparing International Standards is normally carried out through ISO technical committees. Each member body interested in a subject for which a technical committee has been established has the right to be represented on that committee. International organizations, governmental and non-governmental, in liaison with ISO, also take part in the work. ISO collaborates closely with the International Electrotechnical Commission (IEC) on all matters of electrotechnical standardization.

The procedures used to develop this document and those intended for its further maintenance are described in the ISO/IEC Directives, Part 1. In particular the different approval criteria needed for the different types of ISO documents should be noted. This document was drafted in accordance with the editorial rules of the ISO/IEC Directives, Part 2 (see www.iso.org/directives).

Attention is drawn to the possibility that some of the elements of this document may be the subject of patent rights. ISO shall not be held responsible for identifying any or all such patent rights. Details of any patent rights identified during the development of the document will be in the Introduction and/or on the ISO list of patent declarations received (see www.iso.org/patents).

Any trade name used in this document is information given for the convenience of users and does not constitute an endorsement.

For an explanation on the meaning of ISO specific terms and expressions related to conformity assessment, as well as information about ISO's adherence to the World Trade Organization (WTO) principles in the Technical Barriers to Trade (TBT) see the following URL: www.iso.org/iso/foreword.html.

The committee responsible for this document is ISO/TC 44, *Welding and allied processes*, Subcommittee SC 5, *Testing and inspection of welds*.

This second edition cancels and replaces the first edition (ISO 17637:2003), which has been technically revised.

Requests for official interpretations of any aspect of this International Standard should be directed to the Secretariat of ISO/TC 44/SC 5 via your national standards body. A complete listing of these bodies can be found at www.iso.org.

Non-destructive testing of welds — Visual testing of fusion-welded joints

1 Scope

This document specifies the visual testing of fusion welds in metallic materials. It may also be applied to visual testing of the joint prior to welding.

2 Normative references

There are no normative references in this document.

3 Terms and definitions

No terms and definitions are listed in this document.

ISO and IEC maintain terminological databases for use in standardization at the following addresses:

- IEC Electropedia: available at <http://www.electropedia.org/>
- ISO Online browsing platform: available at <http://www.iso.org/obp>

4 Test conditions and equipment

The illuminance at the surface with white light shall be a minimum of 350 lx; wearing of tinted goggles (e.g. protective sunglasses) increases the minimum illuminance. However, 500 lx is recommended.

For direct inspection, the access shall be sufficient to place the eye within 600 mm of the surface to be examined and at an angle not less than 30° (see [Figure 1](#)).

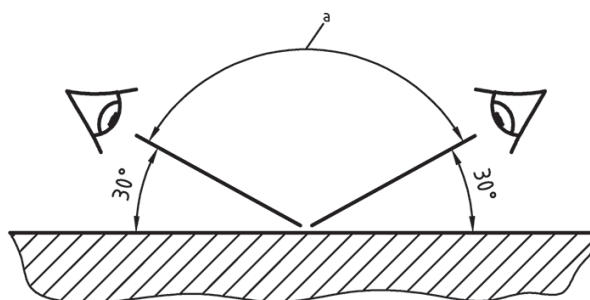

a Range.

Figure 1 — Access for testing

Remote inspection using mirrors, boroscopes, fibre optic cables or cameras shall be considered when the access for testing in accordance with [Figure 1](#) is not possible or when specified by an application standard.

An additional light source can be used to increase the contrast and relief between imperfections and the background.

ISO 17637:2016(E)

Where the result of visual testing is inconclusive, the visual test should be supplemented by other non-destructive testing methods for surface inspections.

Examples of equipment used for visual testing are given in [Annex A](#).

5 Personnel qualification

Visual testing of welds and the evaluation of results for final acceptance shall be performed by qualified and capable personnel. It is recommended that the personnel performing indirect visual testing is qualified according to ISO 9712 or at an appropriate level in the relevant industry sector.

6 Visual testing

6.1 General

This document does not define the extent of visual testing. However, this should be determined in advance, e.g. by reference to an application or product standard.

The examiner shall have access to the necessary inspection and production documentation required.

Any visual testing prior to, during or after completion of the weld should be carried out while physical access is still possible. This may include the visual testing of surface treatments.

6.2 Visual testing of joint preparation

When visual testing is required prior to welding, the joint shall be examined to check the following:

- a) the shape and dimensions of the weld preparation meet the requirements of the welding procedure specification;
- b) the fusion faces and adjacent surfaces are clean and any required surface treatment has been carried out in accordance with the application or product standard;
- c) the parts to be welded are correctly fixed in relation to each other according to drawings or instructions.

6.3 Visual testing during welding

When required, the weld shall be tested during the welding process to check the following:

- a) each run or layer of weld metal is cleaned before it is covered by a further run, particular attention being paid to the junctions between the weld metal and the fusion face;
- b) there are no visible imperfections, e.g. cracks or cavities; if imperfections are observed, they shall be reported so that remedial action can be taken before the deposition of further weld metal;
- c) the transition between the runs and between the weld and the parent metal is so formed that satisfactory melting can be accomplished when welding the next run;
- d) the depth and shape of gouging is in accordance with the WPS or compared with the original groove shape in order to ensure complete removal of the weld metal as specified;
- e) after any necessary repairs/remedial action, the weld conforms to the original requirements of the WPS.

6.4 Visual testing of the finished weld

6.4.1 General

The finished weld shall be examined to determine whether it meets the requirements of the application or product standard or other agreed acceptance criteria, e.g. ISO 5817 or ISO 10042. Finished welds shall at least be examined in accordance with the requirements given in [6.4.2](#) to [6.4.5](#).

6.4.2 Cleaning and dressing

The weld shall be examined to check the following:

- a) all slag has been removed by manual or mechanical means in order to avoid imperfections being obscured;
- b) there are no tool impressions or blow marks;
- c) when weld dressing is required, overheating of the joint due to grinding is avoided and that grinding marks and an uneven finish are also avoided;
- d) for fillet welds and butt welds to be dressed flush, the joint merges smoothly with the parent metal without under flushing.

If imperfections (caused by dressing or otherwise) are observed, they shall be reported so that remedial action can be taken.

6.4.3 Profile and dimensions

The weld shall be examined to check the following:

- a) the profile of the weld face and the height of any excess weld metal meet the requirements of the acceptance criteria (see [6.4.1](#));
- b) the surface of the weld is regular: the pattern and the pitch of weave marks present an even and satisfactory visual appearance; the distance between the last layer and the parent metal or the position of runs has been measured where required by the WPS;
- c) the weld width is consistent over the whole of the joint and that it meets the requirements given in the weld drawing or acceptance criteria (see [6.4.1](#)); in the case of butt welds, the weld preparation shall be checked to ensure it has been completely filled and meets the requirements of drawing or acceptance criteria (see [6.4.1](#)).

6.4.4 Weld root and surfaces

The visually accessible parts of the weld, i.e. the weld root for a single-sided butt weld and the weld surfaces, shall be examined for deviations from the acceptance criteria (see [6.4.1](#)).

The weld shall be examined to check the following:

- a) in the case of single-sided butt welds, the penetration, root concavity and any burn-through or shrinkage grooves are within the limits specified in the acceptance criteria over the whole of the joint;
- b) any undercut is within the limits indicated in the acceptance criteria;
- c) any imperfections such as cracks or porosity, detected using optical aids when necessary, in the weld surface or heat affected zones comply with the appropriate acceptance criteria;
- d) any attachments temporarily welded to the object to facilitate production or assembly and which are prejudicial to the function of the object or the ability to examine it are removed so that the

ISO 17637:2016(E)

object is not damaged; the area where the attachment was fixed shall be checked to ensure freedom of cracks;

- e) any arc strikes are within the limits of the acceptance criteria.

6.4.5 Post-weld heat treatment

Final testing shall be done after heat treatment.

6.5 Visual testing of repaired welds

6.5.1 General

When welds fail to comply wholly or in part with the acceptance criteria and repair is necessary, the welded joint shall be examined in accordance with [6.5.2](#) and [6.5.3](#) prior to re-welding.

Every repaired weld shall be re-examined to the same requirements as the original weld.

6.5.2 Partially removed weld

The excavation shall be sufficiently deep and long to remove all imperfections. The excavation shall be tapered from the base of the cut to the surface of the weld metal at both the ends and sides of the cut. The width and profile of the cut shall be such that there is adequate access for re-welding.

6.5.3 Completely removed weld

When a defective weld has been completely removed, with or without the need for a new section to be inserted, the shape and dimensions of the weld preparation shall meet the specified requirements for the original weld.

7 Test records

When test records are required, at least the following information should be included in the report:

- a) the name of the component manufacturer;
- b) the name of the testing body, if different from a);
- c) the identity of the object tested;
- d) the material;
- e) the type of joint;
- f) the material thickness;
- g) the welding process;
- h) an acceptance criteria;
- i) the imperfections exceeding the acceptance criteria and their location;
- j) the extent of testing with reference to drawings as appropriate;
- k) the test devices used;
- l) the result of testing with reference to acceptance criteria;
- m) the name of tester and date of test.

Welds that have been tested and approved should be suitably marked or identified.

If a permanent visual record of an examined weld is required, photographs or accurate sketches or both should be made with any imperfections clearly indicated.

Annex A (informative)

Examples of test equipment

A.1 The following is a list of equipment typically used for carrying out visual tests of welded joints.

A.1.1 Straight edge or measuring tape, with a graduation of 1 mm or finer.

A.1.2 Vernier calliper, in accordance with ISO 13385.

A.1.3 Feeler gauge, with a sufficient number of feelers to measure dimensions between 0,1 mm and 3 mm in steps of 0,1 mm at most.

A.1.4 Radius gauge.

A.1.5 Magnifying lens, with a magnification of $\times 2$ to $\times 5$; the lens should preferably have a scale (see ISO 3058).

A.1.6 Lamps.

A.2 The following equipment may also be needed.

A.2.1 Profile measuring device, with a wire diameter or width ≤ 1 mm, where each wire end is rounded.

A.2.2 Material for impression of welds, e.g. cold setting plastic or clay.

A.2.3 For visual inspection of welds with limited accessibility, mirrors, endoscopes, boroscopes, fibre optics or TV-cameras may be used.

A.2.4 Other measurement devices, e.g. specifically designed welding gauges, height/depth gauges, rulers or protractors.

A.3 Typical measurement devices and gauges are listed in detail in [Table A.1](#).

NOTE These devices and gauges are included as examples of testing equipment. Some of the designs may be registered designs or the subject of patents.

Table A.1 — Measuring instruments and weld gauges — Measuring ranges and reading accuracy

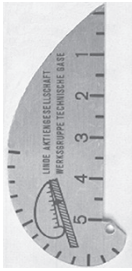
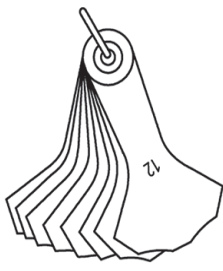
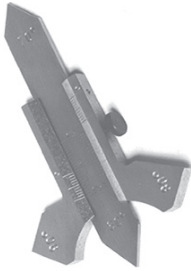
Weld gauge	Description	Type of weld			Measuring range mm	Reading accuracy mm	Included or fillet angle degrees	Permissible deviation of included or fillet angle
		Flat weld	Fillet weld Concave weld	Convex weld				
	<p>Simple weld gauge</p> <p>a) Measures fillet weld from 3 mm to 15 mm thickness. The gauge is placed by the curved part in the fusion faces so as to have three points of contact with the work piece and the fillet weld.</p> <p>b) Measures butt welds reinforcement with the straight part.</p> <p>Because the gauges consist of relatively soft aluminium, they wear out rapidly.</p>	x	x	—	x	≈0,5	90	Small
	<p>Set of welding gauges</p> <p>Measures fillet welds from 3 mm to 12 mm thickness; from 3 mm to 7 mm: graduations of 0,5 mm; above 8 mm, 10 mm and 12 mm. The gauge measures by using the principle of three-point contact.</p>	x	x	—	—	According to fan part	90	None
	<p>Weld gauge with Vernier</p> <p>Measures fillet welds; also reinforcement of butt welds can be determined. The legs of the gauge are so formed that included angles of 60°, 70°, 80° and 90° of V- and single-V butt weld with broad face can be measured. Slight deviations from these lead to significant errors.</p>	x	x	—	x	0,1	90	None

ISO 17637:2016(E)

Table A.1 (continued)







Weld gauge	Description	Type of weld			Measuring range mm	Reading accuracy mm	Included or fillet angle degrees	Permissible deviation of included or fillet angle
		Flat weld	Fillet weld Concave weld	Convex weld				
	Self-made weld gauge Measures 7 throat thicknesses of fillet welds with an included angle of 90°.	x	—	—	0 to 20	0,2	90	None
	Three-scale weld gauge Measures throat thickness and leg length. Can also measure weld reinforcement of butt welds. Easy to use. Also appropriate for asymmetric fillet welds.	x	x	x	0 to 15	0,1	90	Small
	Gauge for checking profile of fillet welds Checking the profile of one shape for one size of fillet welds. This type of gauge needs one model for each size of fillet weld.	—	—	—	—	—	—	—
	Multi-purpose gauge Measures angle of bevel, leg length of fillet weld, undercut, misalignment, throat thickness and weld reinforcement.	x	x	x	0 to 50	0,3	0 to 45 (angle of bevel)	None

Table A.1 (continued)

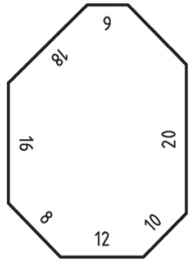
Weld gauge	Description	Type of weld			Measuring range mm	Reading accuracy mm	Included or fillet angle degrees	Permissible deviation of included or fillet angle
		Flat weld	Fillet weld Concave weld	Convex weld				
	Universal weld gauge Measurement tasks: — fillet welds: shape and dimensions. — butt welds: misalignment of plates, joint preparation (angle width), weld reinforcement, weld width, undercuts.	x	x	x	0 to 30	0,1	—	±25 %
	Gap gauge Measures the width of gaps.	—	—	—	0 to 6	0,1	—	—
	Hook gauge for misalignment Measures the misalignment of the preparation for butt welds on plates and pipes.	—	—	—	0 to 100	0,05	—	—
	Universal butt weld gauge Measures the preparation and the finished butt weld. 1 angle of bevel 2 width of root gap 3 weld reinforcement 4 width of weld surface 5 depth of undercut 6 diameter of consumables	x	x	x	0 to 30	0,1	—	±25 %

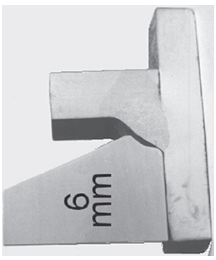
Bibliography

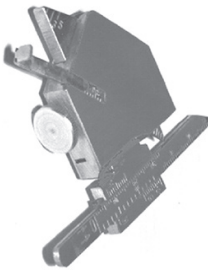
- [1] ISO 3058, *Non-destructive testing — Aids to visual inspection — Selection of low-power magnifiers*
- [2] ISO 5817, *Welding — Fusion-welded joints in steel, nickel, titanium and their alloys (beam welding excluded) — Quality levels for imperfections*
- [3] ISO 9712, *Non-destructive testing — Qualification and certification of NDT personnel*
- [4] ISO 10042, *Welding — Arc-welded joints in aluminium and its alloys — Quality levels for imperfections*
- [5] ISO 13385 (all parts), *Geometrical product specifications (GPS) — Dimensional measuring equipment*
- [6] ISO 17635, *Non-destructive testing of welds — General rules for metallic materials*

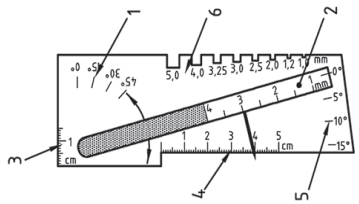
ISO 17637:2016(E)

ICS 25.160.40

Price based on 10 pages

© ISO 2016 – All rights reserved